

SAITAN

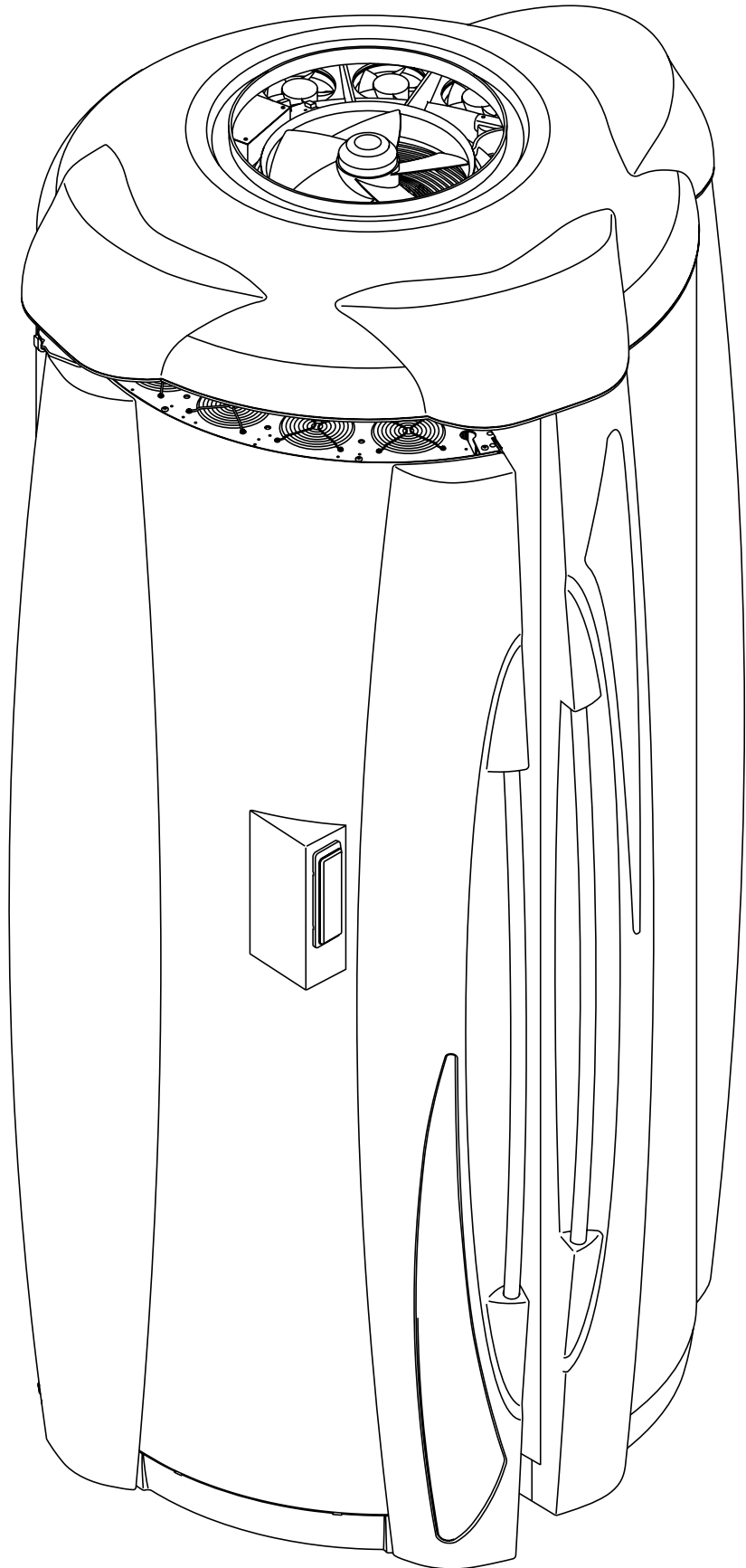

USER MANUAL

Congratulations on your purchase of this technologically advanced sun tanning unit. It has been designed to provide years of dependable service for you.

Please read all the instructions in this booklet before installing and using the unit. Always be sure to observe all safety precautions.

Contents

Safety Information2
Installation4
Pre-Installation Planning4
Unpacking and Inspection4
Hardware Inventory5
Tools Needed5
Assembly Procedures6
Adjusting Hinges24
Stereo Installation25
Electrical Connections26
Remote Connections27
Operation30
Before You Tan30
Exposure Times30
Tanning Position30
Using Your Booth31
Care and Maintenance34
Cleaning After Use34
Hour Counter34
Thorough Periodic Cleaning34
Mechanical Inspection34
Lamp and Acrylic Replacement35
Troubleshooting39
Maintenance Schedule42
Technical Diagrams43
Warranty45

2 - Safety Information



LABELING NOTICE: Labels are affixed on all systems to inform the user of possible dangers. Regulations are stated in 21 CFR, Section 1040.20, and require that all products manufactured after September 8, 1986 which use sunlamps must display the following:

DANGER Ultraviolet radiation. Follow instructions. Avoid overexposure. As with natural sunlight, overexposure can cause eye and skin injury and allergic reactions. Repeated exposure may cause premature aging of the skin and skin cancer. **WEAR PROTECTIVE EYEWEAR; FAILURE TO MAY RESULT IN SEVERE BURNS OR LONGTERM INJURY TO THE EYES.** Medications or cosmetics may increase your sensitivity to the ultraviolet radiation. Consult physician before using sunlamp if you are using medications or have a history of skin problems or believe yourself especially sensitive to sunlight. If you do not tan in the sun, you are unlikely to tan from the use of this product. Children, the elderly, or fair skinned people who always burn easily and either never tan or tan minimally should not use this equipment.

For a uniform tan, center yourself within the booth. Other positions may result in overexposure to parts of your body. Do not use without acrylic panels in place. Untanned persons should not tan on consecutive days during their first week of tanning. Never tan more than once a day. Tanning normally appears after the first few sessions and maximizes after approximately four weeks. Tan once or twice per week thereafter to maintain appearance. Persons already having a base tan may begin at advanced levels corresponding to the extent of their base tan.

RECOMMENDED EXPOSURE TIMES IN MINUTES		MAXIMUM EXPOSURE TIME IS 8 MINUTES				
Skin Type:		Level 1/Week 1 1st-3rd Sessions	Level 2	Level 3	Level 4	Subsequent Maximum
I Sensitive Skin	(Burns easily and severely and does not tan.)	NOT RECOMMENDED FOR TANNING				
II Light	(Burns easily and severely and tans minimally.)	2	3	5	7	8
III Normal	(Burns moderately and tans average.)	3	4	6	8	8
IV Dark	(Burns minimally, tans easily and above average.)	4	5	7	8	8

New lamps emit approximately 10% more ultraviolet radiation during the first 50 hours of operation. Recommended tanning times should therefore be reduced by approximately 10% during that period.

WARNING: • Read the instructions booklet before using this sunlamp product. • All persons in the room should wear protective eyewear when lamps are on. Recommended eyewear: provided eyeshields or equivalent eyewear as defined under 21 CFR 1040.20. Other types of eyewear may not provide adequate protection. Failure to use protective eyewear may result in severe burns or other eye injury. If discomfort develops, discontinue use and consult a physician.

ONLY THE FOLLOWING LAMPS HAVE BEEN CERTIFIED FOR USE IN THE ELITE 756V:

BRONZING SUN™ GOLD Wolff® Model BSG 79-T12-200W VS-R BI-PIN

**DISCONNECT POWER BEFORE ATTEMPTING TO CLEAN, RELAMP,
OR ENGAGE IN THE MAINTENANCE OF THIS PRODUCT.**

THIS EQUIPMENT MUST BE EARTH GROUNDED.

This product is in conformity with performance standards for sun lamp products under 21 CFR PART 1040.20 and ANSI/UL Standard 482. Certified to CAN/CSA Standard C22.2 NO. 224.





DANGER Rayonnement ultraviolet. Veuillez suivre les instructions. Évitez une exposition excessive; tout comme pour les rayons du soleil, une exposition excessive peut causer des blessures aux yeux et à la peau et provoquer des réactions allergiques. Une exposition répétée peut causer le vieillissement prématuré de la peau et provoquer le cancer de la peau. **PORTEZ DES LUNETTES PROTECTRICES: LE NON-RESPECT DE CETTE CONSIGNE DE SÉCURITÉ PEUT ENTRAÎNER DE GRAVES BRÛLURES OU DES LÉSIONS OCULAIRES À LONG TERME.** Les médicaments ou les produits cosmétiques peuvent augmenter votre sensibilité au rayonnement ultraviolet. Consultez un médecin avant d'utiliser la lampe solaire si vous prenez des médicaments, si vous souffrez d'une maladie cutanée ou si vous croyez être particulièrement sensible aux rayons du soleil. Si vous ne bronzez pas au soleil, il est peu probable que vous bronzez sous une lampe solaire. Les enfants, les personnes âgées et les personnes qui ont une peau claire qui brûle facilement, ne bronze jamais ou alors très peu, ne devraient pas utiliser cette lampe.

Pour un bronzage uniforme, placez-vous au centre du compartiment. Un mauvais alignement peut causer une exposition excessive de certaines parties du corps. N'utilisez pas la lampe sans les panneaux de plastique transparents. La première semaine de bronzage, les personnes qui n'ont pas un hâle initial ne doivent pas se faire bronzer tous les jours. Ne vous faites jamais bronzer plus d'une fois par jour. Le bronzage commence normalement à apparaître après les premières séances : il atteint son apogée au bout d'environ quatre semaines. Les personnes qui ont déjà un teint hâlé peuvent commencer à des niveaux plus élevés, selon l'importance de leur hâle initial.

TEMPS D'EXPOSITION RECOMMANDÉ EN MINUTES		LE TEMPS D'EXPOSITION MAXIMAL EST DE 8 MINUTES				
Type de peau:		Élevé 1/Semaine 1 1st-3rd Sessions	Élevé 2	Élevé 3	Élevé 4	Sem. suivantes Temps maximal
I Peau sensible (brûle facilement et ne bronze pas)	NON RECOMMANDÉ					
II Peau claire (brûle facilement et bronze très peu)		2	3	5	7	8
III Peau normale (brûle et bronze de façon modérée)		3	4	6	8	8
IV Peau foncée (brûle très peu, bronze plus facilement que la moyenne)		4	5	7	8	8

Les lampes neuves émettent approximativement 10 % de plus de rayons ultraviolets au cours des 50 premières heures de fonctionnement. Le temps de bronzage doit donc être réduit d'environ 10 % pendant cette période.

AVERTISSEMENT : • Lisez le livret d'instructions avant d'utiliser cette lampe solaire. • Les autres personnes présentes dans la pièce doivent aussi porter des lunettes protectrices lorsque les lampes sont allumées. Coquilles de protection pour les yeux recommandées: Les coquilles de protection fournies ou l'équivalent, tel que le stipule le document 21 CFR 1040.20. Les autres types de lunettes protectrices peuvent ne pas assurer une protection adéquate. Utilisé sans lunettes protectrices, ce produit peut causer des brûlures ou lésions oculaires graves. Si vous souffrez d'un malaise, arrêtez l'utilisation et consultez un médecin.

SEULES LES LAMPES INDIQUÉES CI-DESSOUS ONT ÉTÉ HOMOLOGUÉES POUR CET ÉQUIPEMENT:

BRONZING SUN™ GOLD Wolff® Modèle BSG 79-T12-200W VS-R BI-PIN

**Débrancher l'alimentation électrique avant de nettoyer l'appareil ,
d'en faire l'entretien ou de changer les lampes.**

Cet équipement doit être mis à la terre.

Ce produit est conforme aux normes de rendement pour les lampes solaires dans le documents 21 CFR, partie 1040.20 , ANSI/UL 482 , CAN/CSA C22.2 N° 224.



Pre-Installation Planning

Before your booth is installed, you should observe the following considerations.

	⚠ DANGER
	Shock hazard. Disconnect power before servicing.

⚠ CAUTION
Use of a voltage source above 230V AC (with unit running) may prevent proper operation of the unit and could cause damage and void the warranty.

⚠ CAUTION
Air from the room is used to cool the unit. Maximum ambient room temperature should be 80°F. Place your booth no closer than 6" from walls. Make sure nothing obstructs the airflow into or out of the fan openings. A poorly ventilated room may cause the unit to become hot and cause discomfort to the user.

⚠ CAUTION
Proper assembly of your booth requires at least three people. Plan to have a few helpers assist you.

- The **ELITE 756V** requires a dedicated circuit capable of providing either **40 Amp, 3-phase** service (3 wire plus ground) or **69A, 1-phase** service (2 wire plus ground) at **220VAC**. This unit must be hardwired directly to a junction box on a dedicated circuit. We recommend connection by a professional electrician. Consult local and/or national codes for proper circuit breaker and wire gauge.
- **IMPORTANT!** Operating voltage must be below 230V AC or may require a Buck Booster.

⚠ WARNING
Always wear protective eyewear when unit is on. Failure to may result in severe burns or longterm injury to the eyes.

Unpacking and Inspection

The ELITE 756V arrives in eight boxes. For ease of assembly, after inspection leave everything in its original box until called for in the assembly instructions.

Open each box and inspect the contents to make sure they are free from any visible damage. Report the extent of any damage to the transportation company.

Note! The cartons are reusable. You may wish to save them for future use.

As you unpack your boxes you should find the following:

- Right Module (box 1)
- Bag containing necessary assembly hardware, and safety goggles (box 1)
- Left Module (box 2)
- Right Door (box 3)
- Left Door (box 4)
- Dome and ceiling assembly (box 5)
- Stereo and installation kit (box 5)
- Two blower assemblies (box 6)
- Base (box 7)
- Two Long Interior Handles (box 8)
- Control Extrusion with keypad (box 8)

Record the serial number of the Right Module in the area provided at the back of this manual. This information will be required if you ever need to call customer service.

Hardware Inventory

Make sure you have all of these items before beginning assembly.

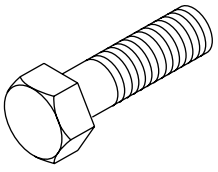
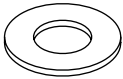
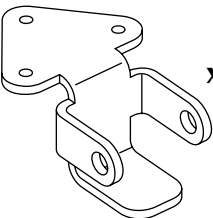
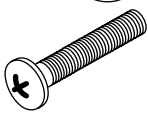
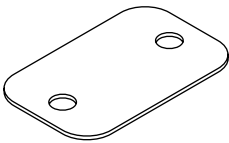
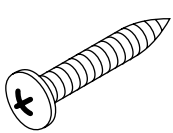
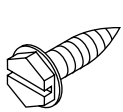
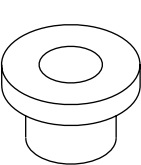
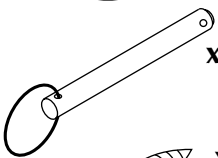
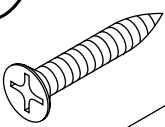
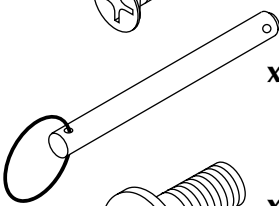
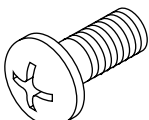
-  **x 10** Bolt, 5/16"-18 x 1"
-  **x 10** Washer, 5/16" flat
-  **x 2** Lower Handle Bracket
-  **x 12** Screw, #8-32 x 3/4"
-  **x 1** Module Strap
-  **x 4** Screw, #10 x 1" Phillips pan head
-  **x 2** Screw, #10 x 1/2" slotted hex washer head
-  **x 4** Hinge Bushing
-  **x 4** Hinge Locking Pin
-  **x 6** Screw, #10 x 1" Phillips flat head
-  **x 2** Handle Pin
-  **x 4** Bolt, 1/4-20 x 5/8" Phillips pan head

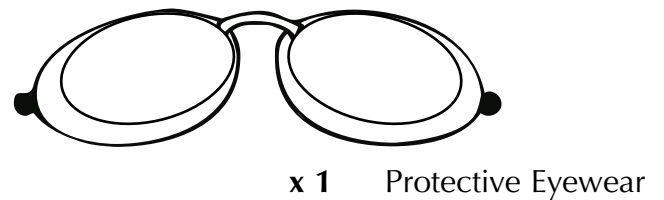
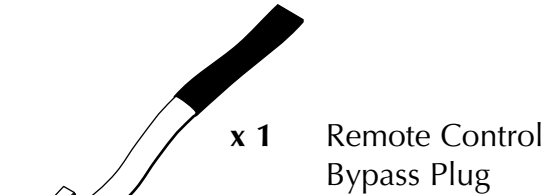
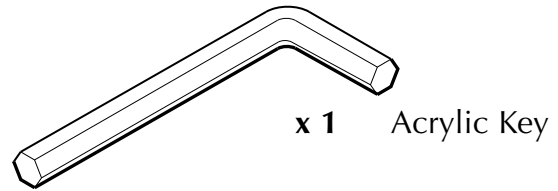

Tools Needed

You will need the following tools to assemble the tanning booth.

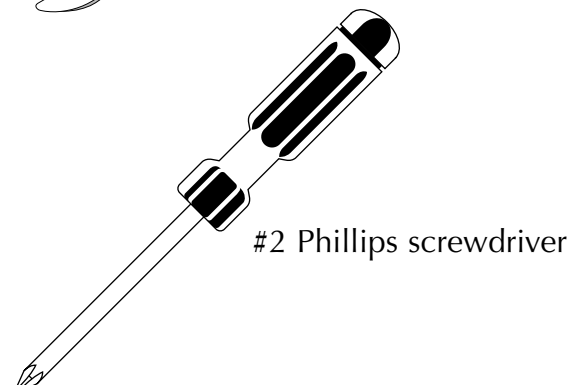
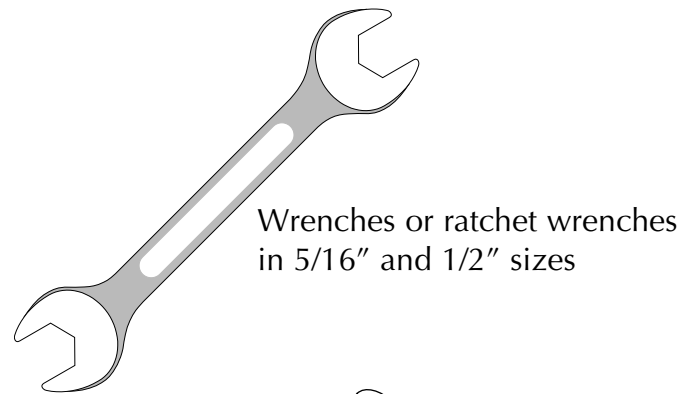

Assembly Procedures

Put the Base (found in *box 7*) in the general area you want the booth. Leave some space around the base to work.

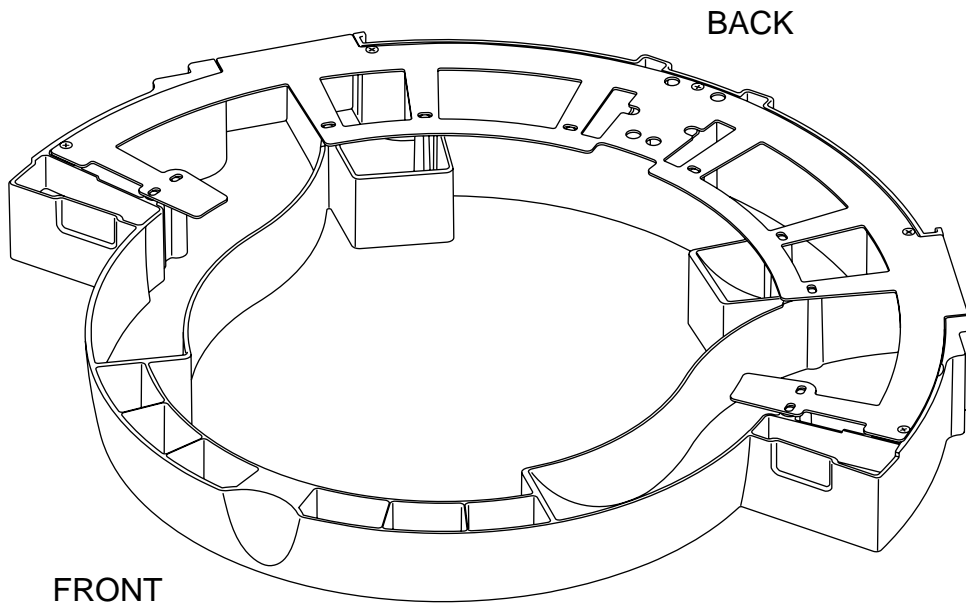

Note on assembly:

These instructions illustrate how to assemble the booth without removing the acrylics. However, you may find it easier to remove the acrylics before beginning.

The Left Module is shown at right. Using the acrylic key (included in the hardware kit) turn the four quarter-turn latches on the acrylic to unlock it. ①Swing the acrylic open, ②lift it and ③pull the bottom out.

To replace the acrylic, insert the top hinge pin in the hole at the top of the module, swing the bottom pin into place and drop it down to engage the pin.

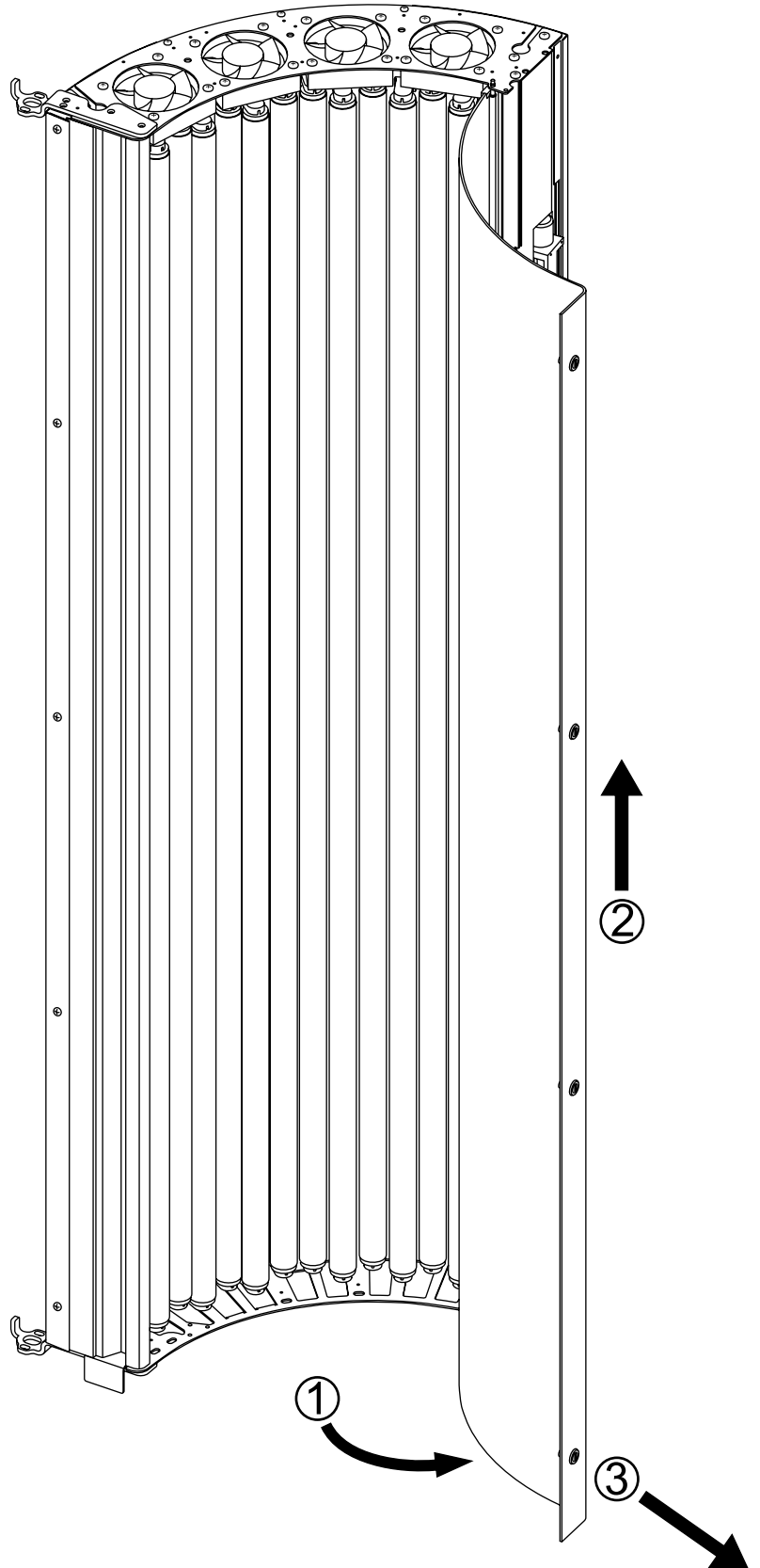

NOTE: Wiring deleted from illustration for clarity.

8 - Assembly Procedures

Parts needed:

Left Module (*box 2*)

Stand the Left Module
on the Base as shown.

The tab on the module fits
into the indentation in the
base for easy positioning

**NOTE: Wiring deleted from
illustration for clarity.**

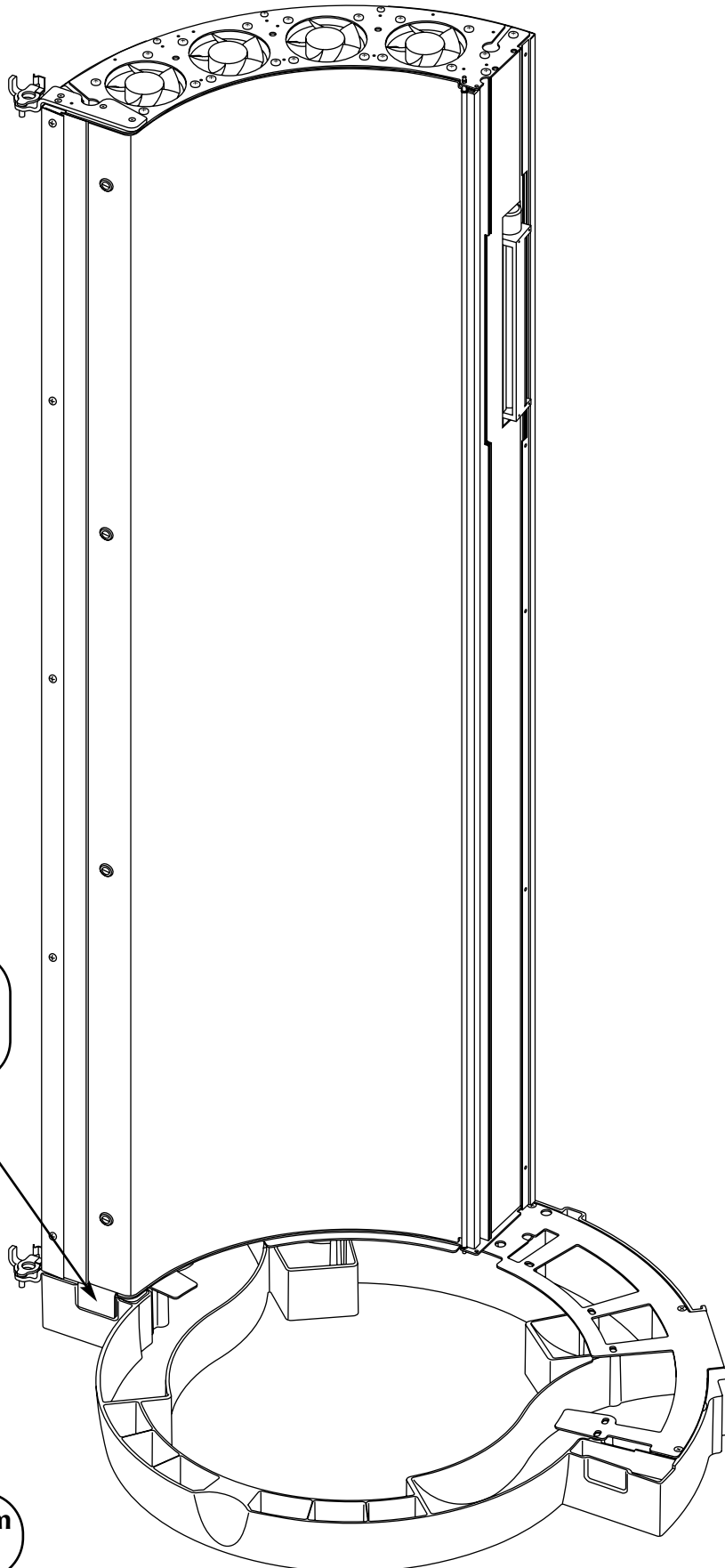

Parts needed:

(5) 5/16-18 x 1" Hex-head bolts

(5) 5/16" Flat washers

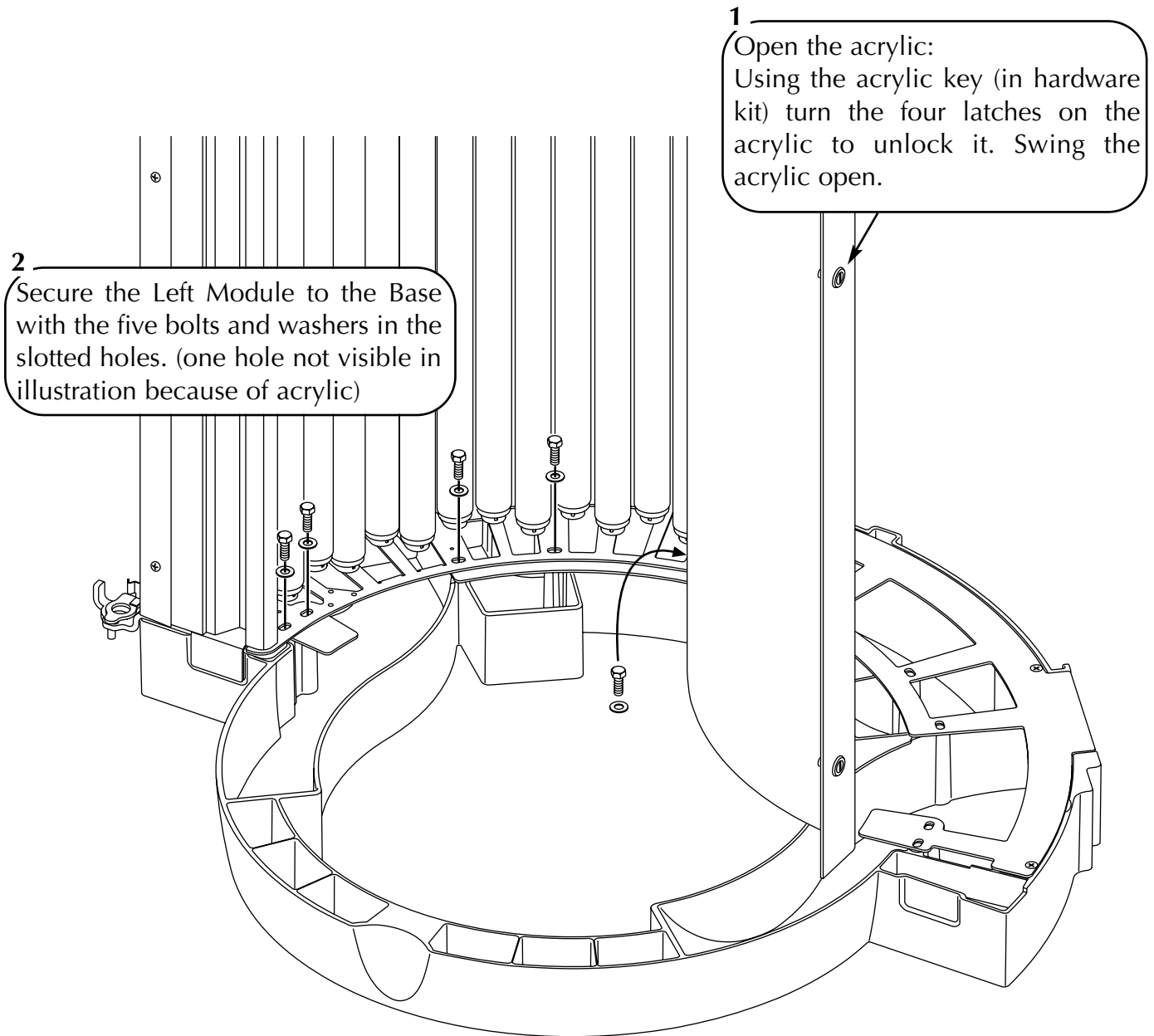

10 - Assembly Procedures

Parts needed:

- (1) Lower handle bracket
- (3) #8-32 x 3/4" Phillips pan-head thread cutting screws

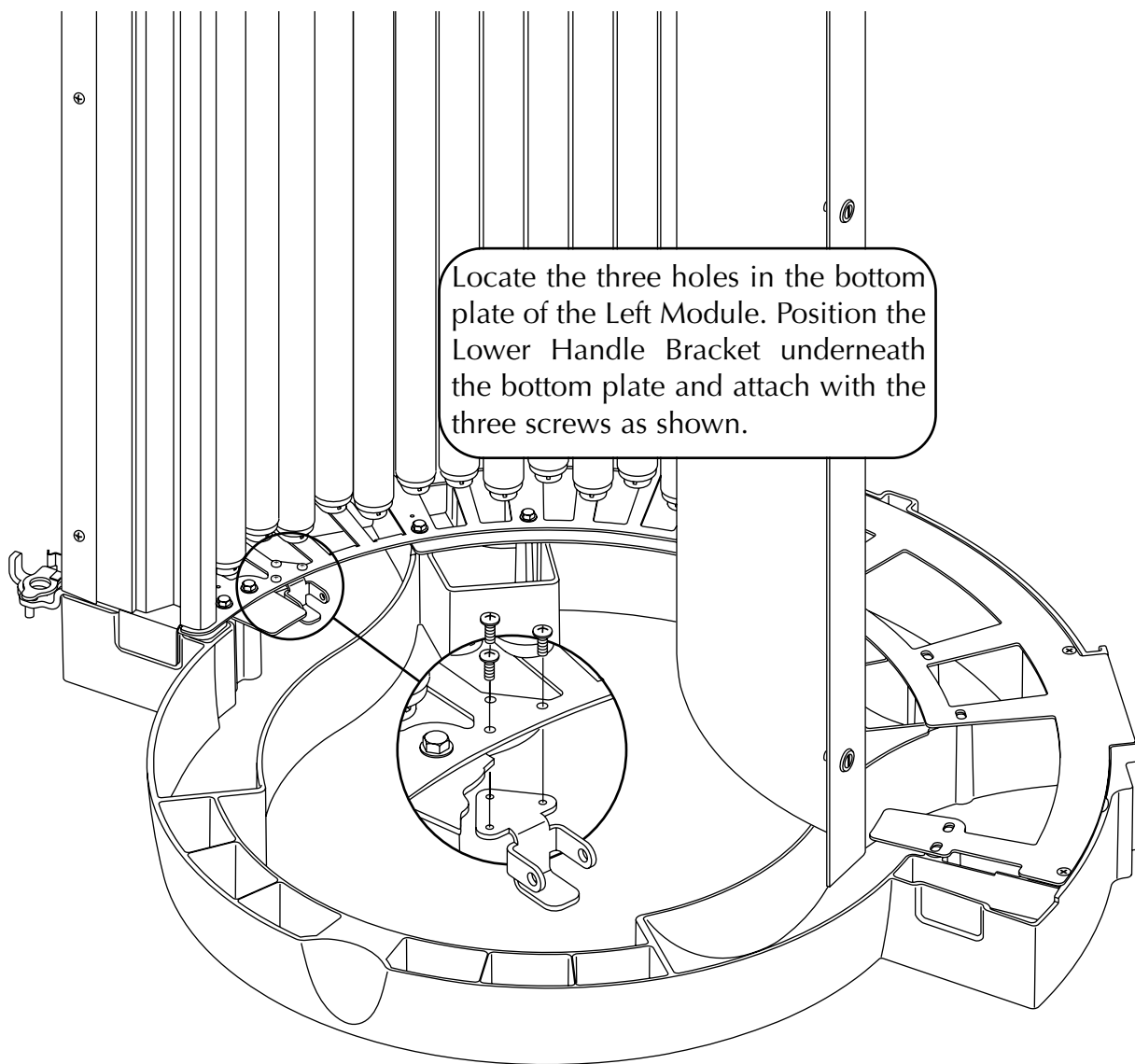

Locate the three holes in the bottom plate of the Left Module. Position the Lower Handle Bracket underneath the bottom plate and attach with the three screws as shown.

Close and lock the acrylic.

Parts needed:
Right Module (box 1)

Stand the Right Module
on the Base as shown.

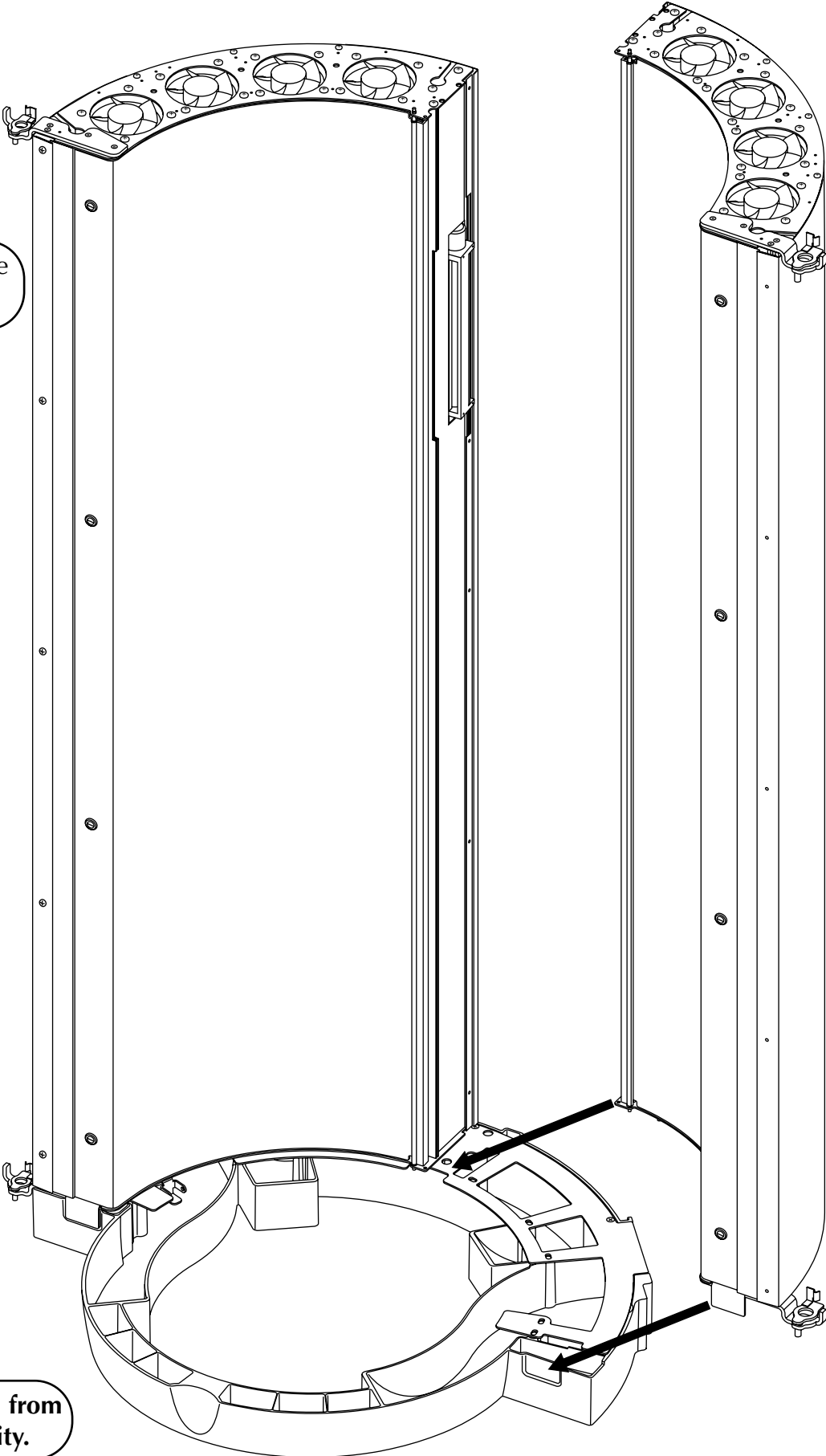

**NOTE: Wiring deleted from
illustration for clarity.**

12 - Assembly Procedures

Parts needed:

- (5) 5/16-18 x 1" Hex-head bolts
- (5) 5/16" Flat washers

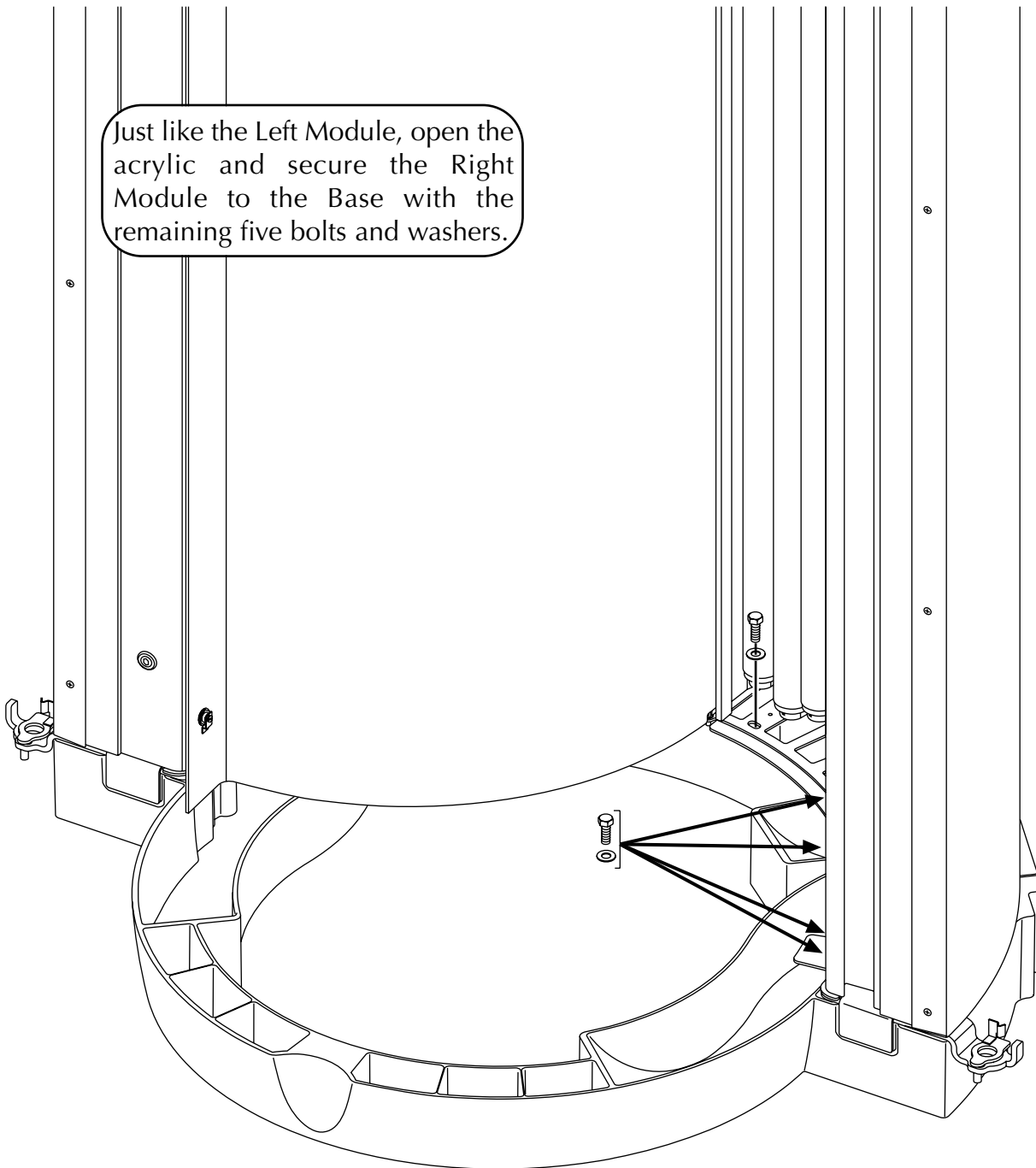

Parts needed:

- (1) Lower handle bracket
- (3) #8-32 x 3/4" Phillips screws

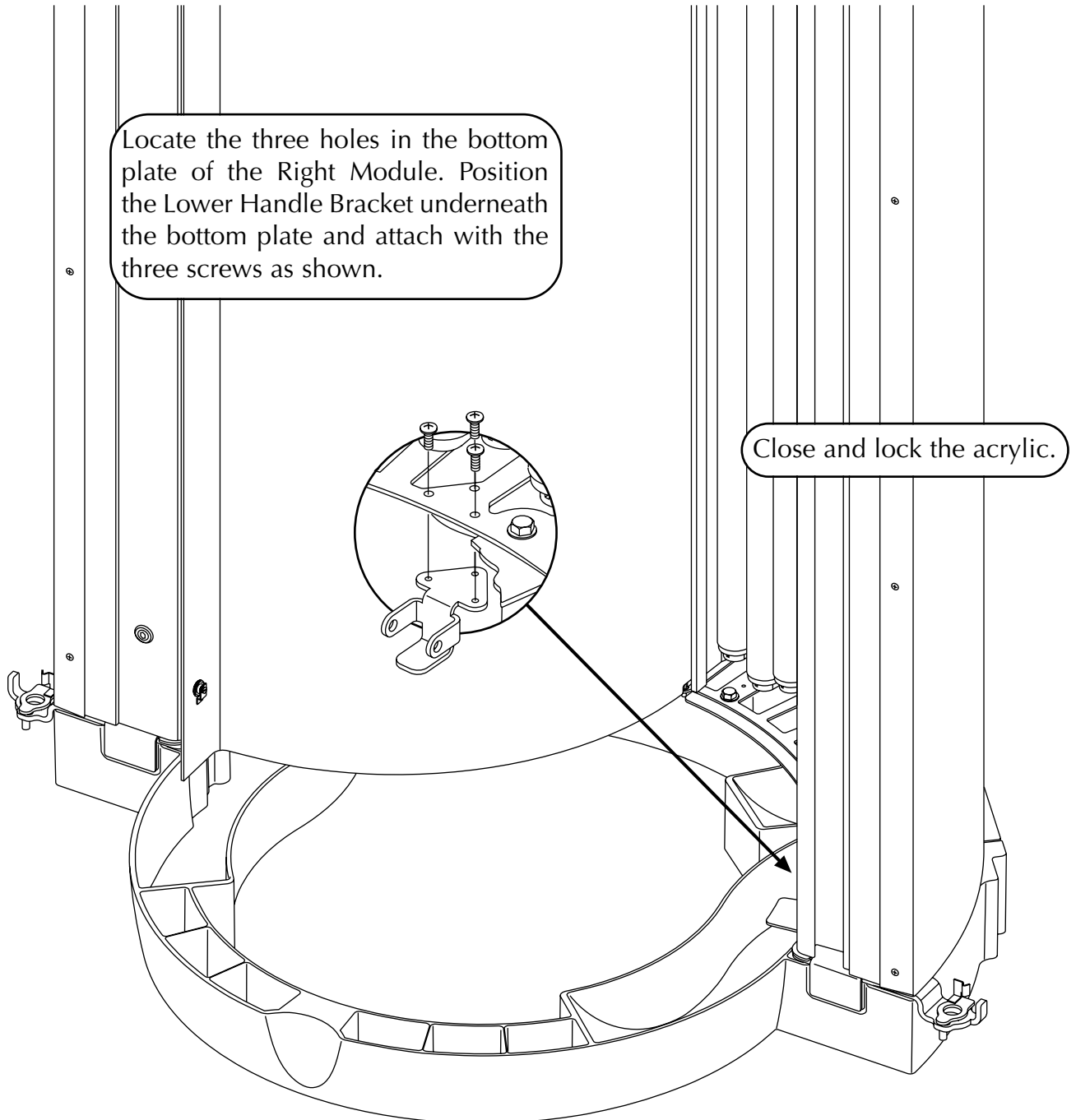

14 - Assembly Procedures

Parts needed:

- (1) Module Strap
- (2) #10 x 1" Phillips pan head screws

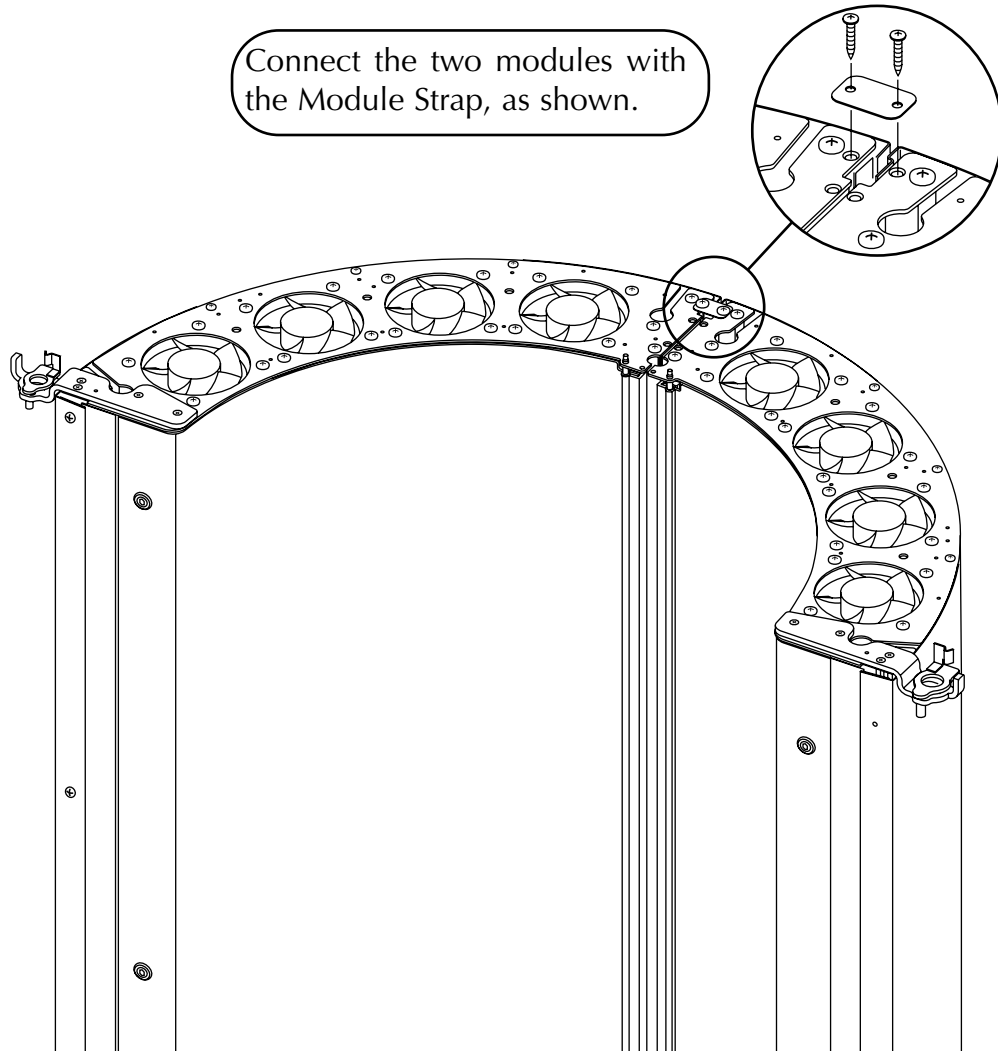

NOTE: Wiring deleted from illustration for clarity.

Parts needed:

Control Extrusion (box 8)

(2) #10 x 1" Phillips pan head screws

(2) #10 x 1/2" slotted hex washer head screws

1 Feed the cable from the Control Extrusion through the hole between the modules.

2 Press the Control Extrusion into place and secure the top with the pan head screws.

3 Secure the bottom of the extrusion with the hex head screws. Use a 5/16" wrench or ratchet.

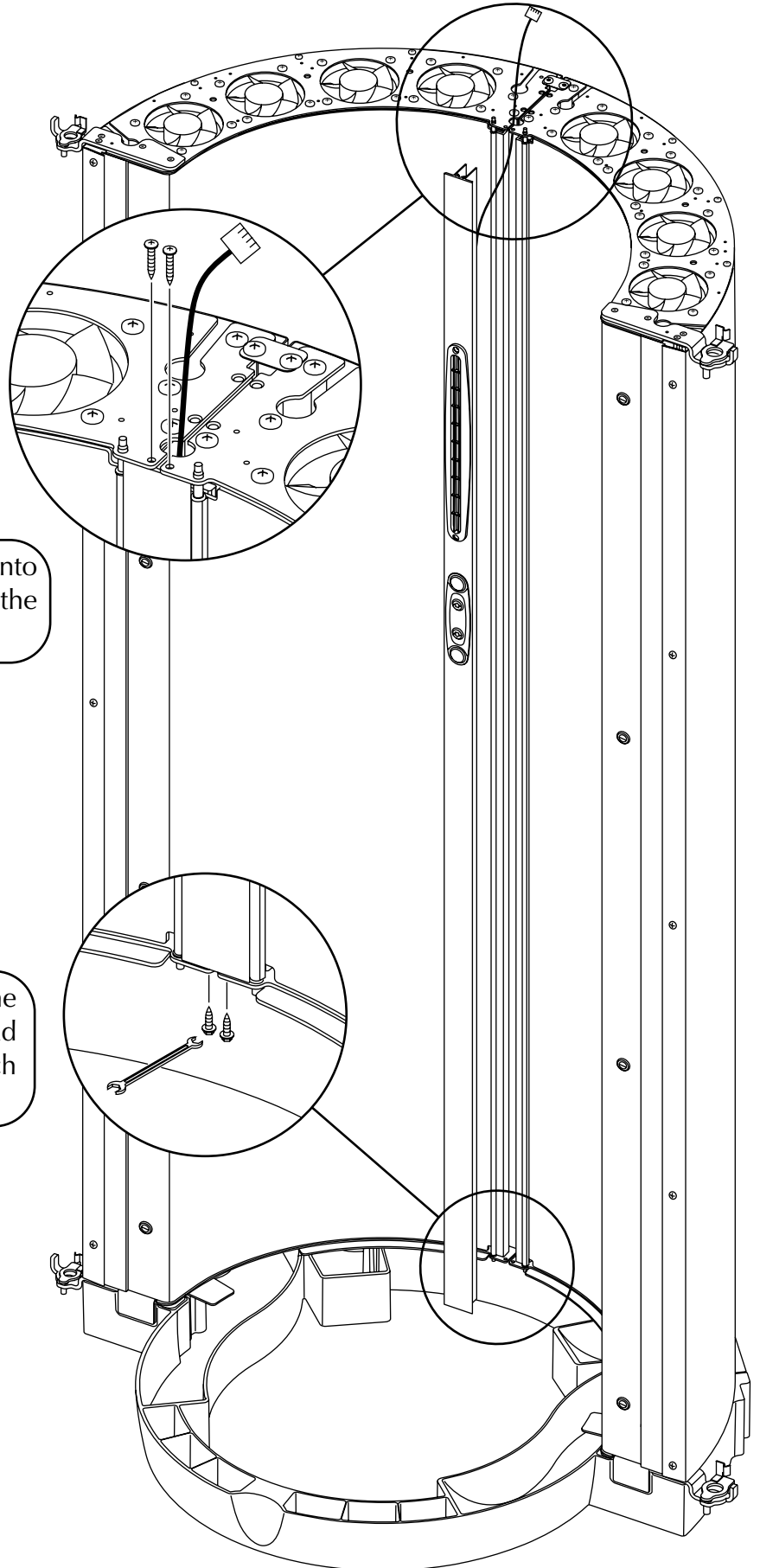

NOTE: Wiring deleted from illustration for clarity.

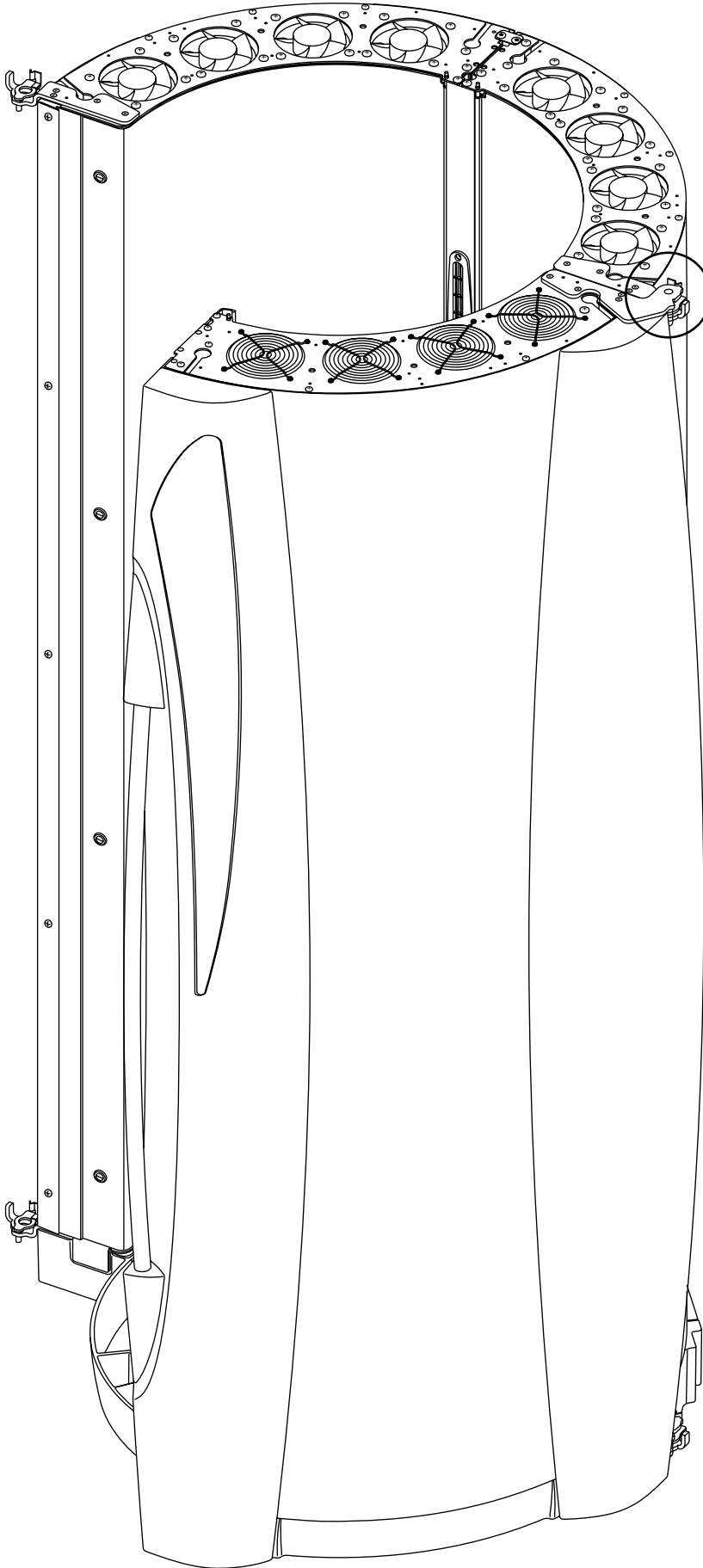

Parts needed:
Right Door (*box3*)
(2) Hinge bushings

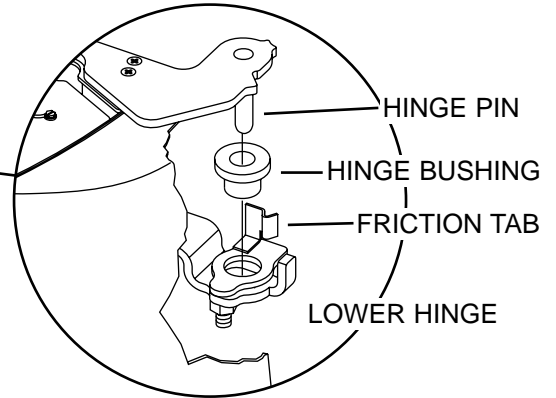

Place the Hinge Bushings into the hinge holes (top and bottom). Carefully lower the door hinge pins into the bushings, being careful not to bend the friction tabs.

NOTE: Wiring deleted from illustration for clarity.

Parts needed:
Left Door (box 4)
(2) Hinge bushings

Place the Hinge Bushings into the hinge holes (top and bottom). Carefully lower the door hinge pins into the bushings, being careful not to bend the friction tabs.

NOTE: Wiring deleted from illustration for clarity.



18 - Assembly Procedures

Parts needed:

Ceiling assembly (box 5)

(6) #8-32 x 3/4" Phillips screws

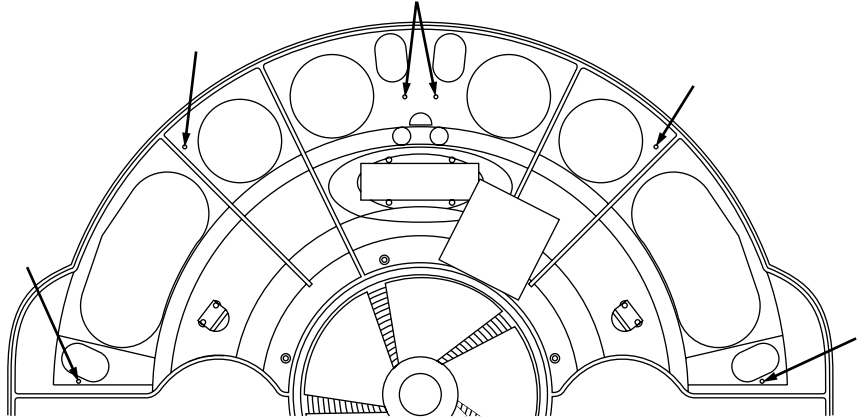

Lower the Ceiling assembly onto the top of the booth. Pass the wiring harnesses (not shown) through the holes directly above each harness so no wires get pinched beneath the Ceiling.

Secure the Ceiling in place with the six screws in the holes indicated by arrows in the detail above, right.

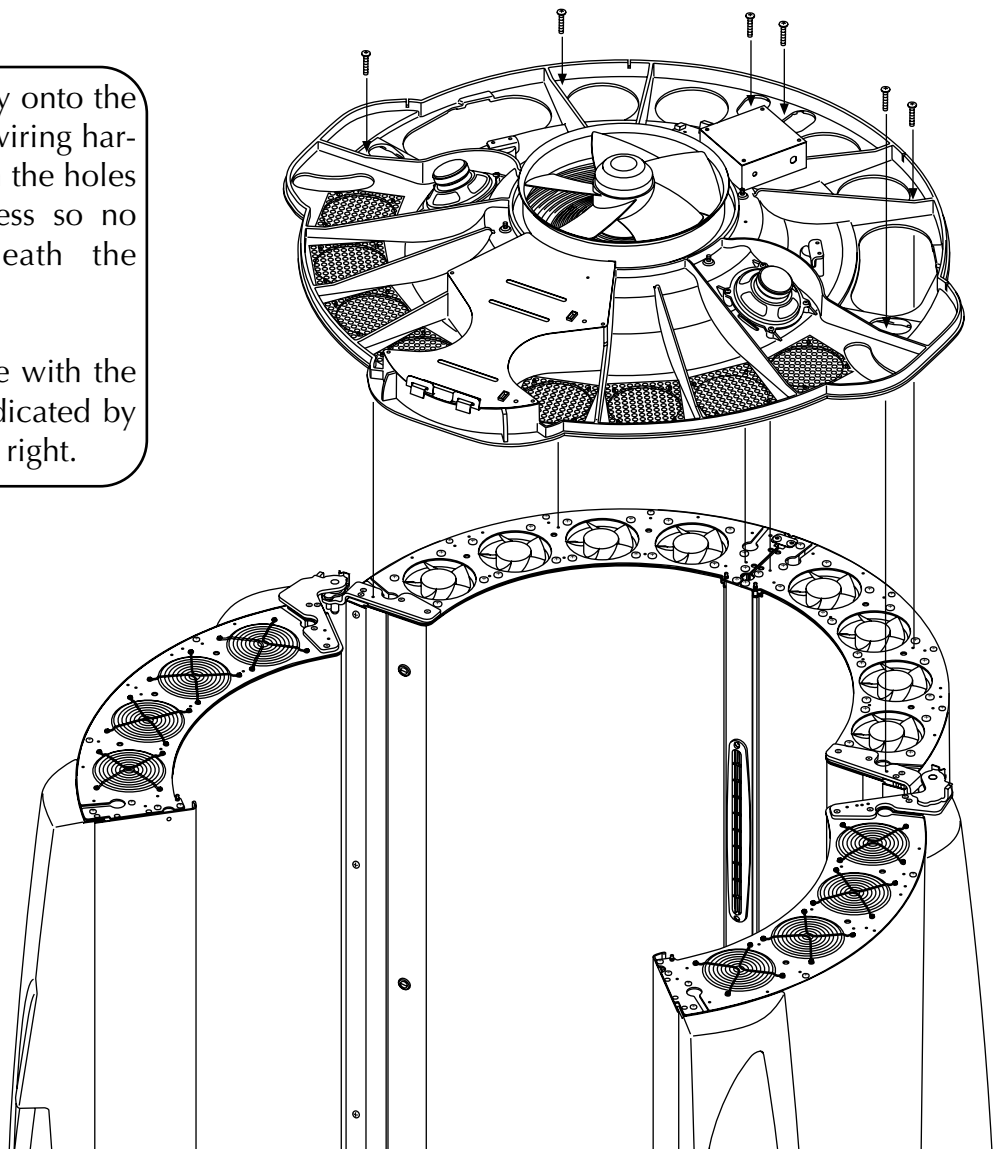

NOTE: Wiring deleted from illustration for clarity.

Connect the wiring harnesses as shown. Match similarly colored harnesses and plug them together firmly. Use care when plugging into the display board.

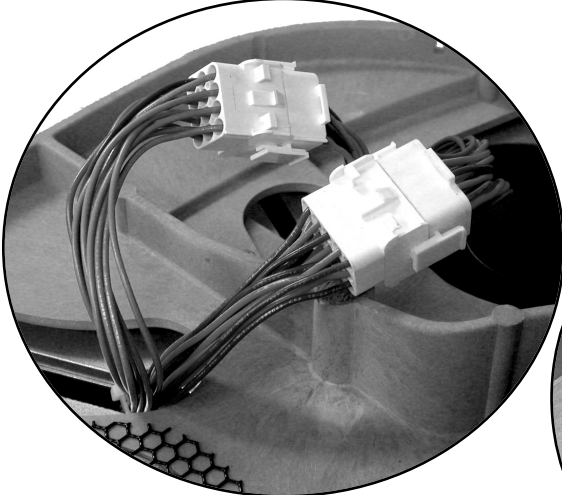

FROM CONTROL EXTRUSION

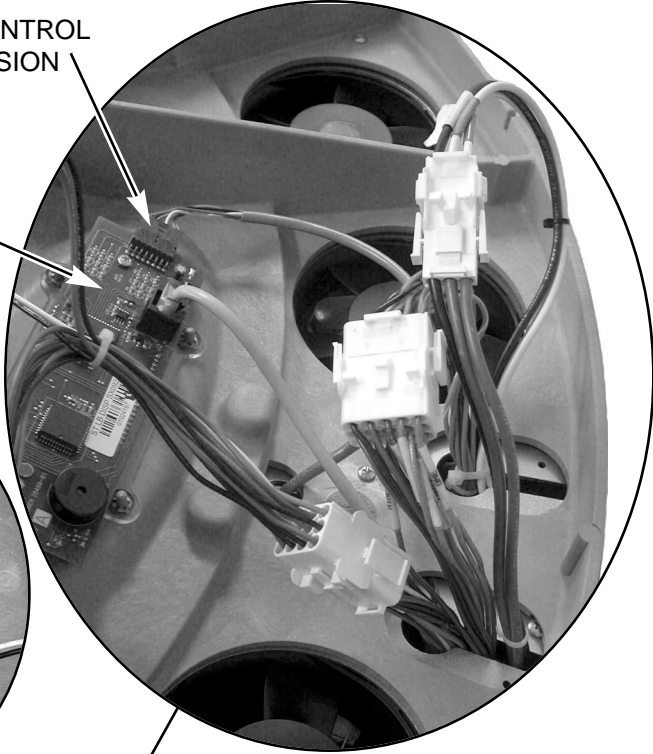

DISPLAY BOARD

FROM RIGHT MODULE

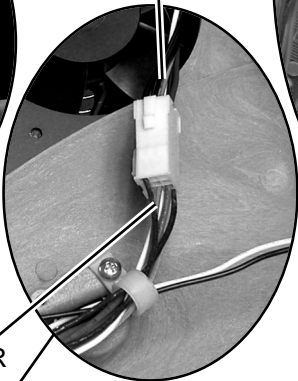

STEREO WIRE FROM LEFT DOOR

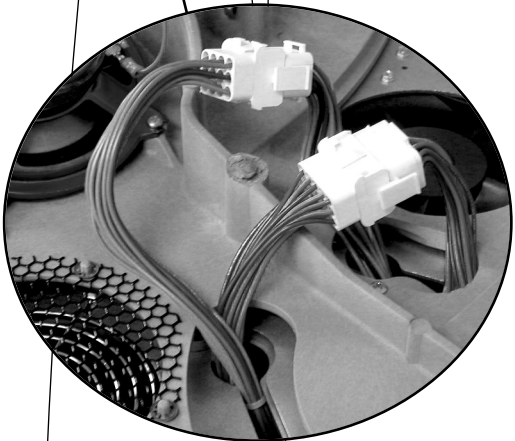
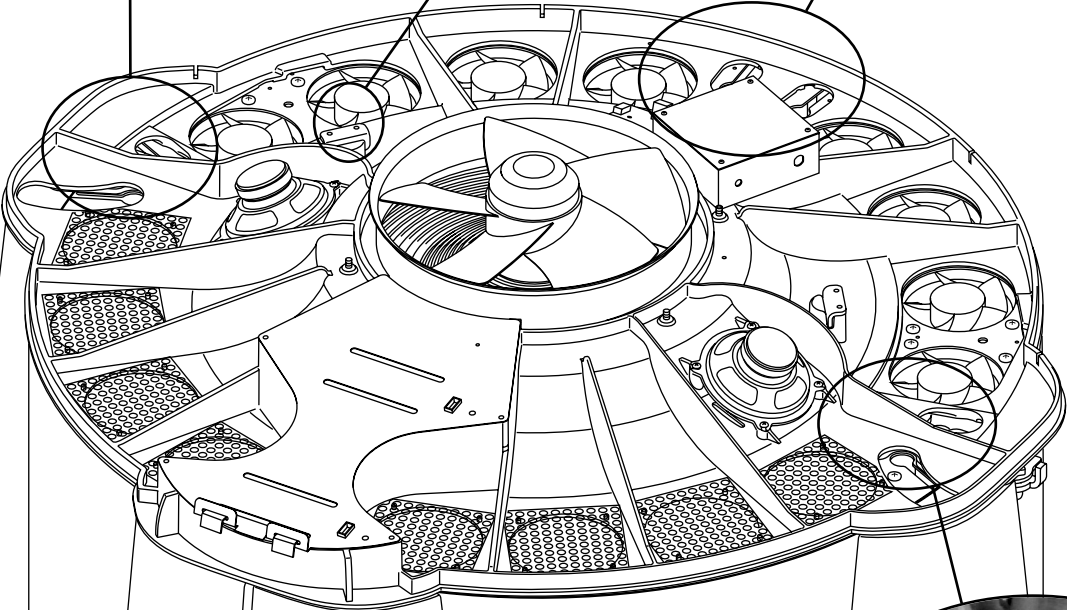

20 - Assembly Procedures

Parts needed:

Dome (box 5)

(6) #10 x 1" Phillips flat head screws

Lower the Dome onto the booth.
Use the six screws to secure it.

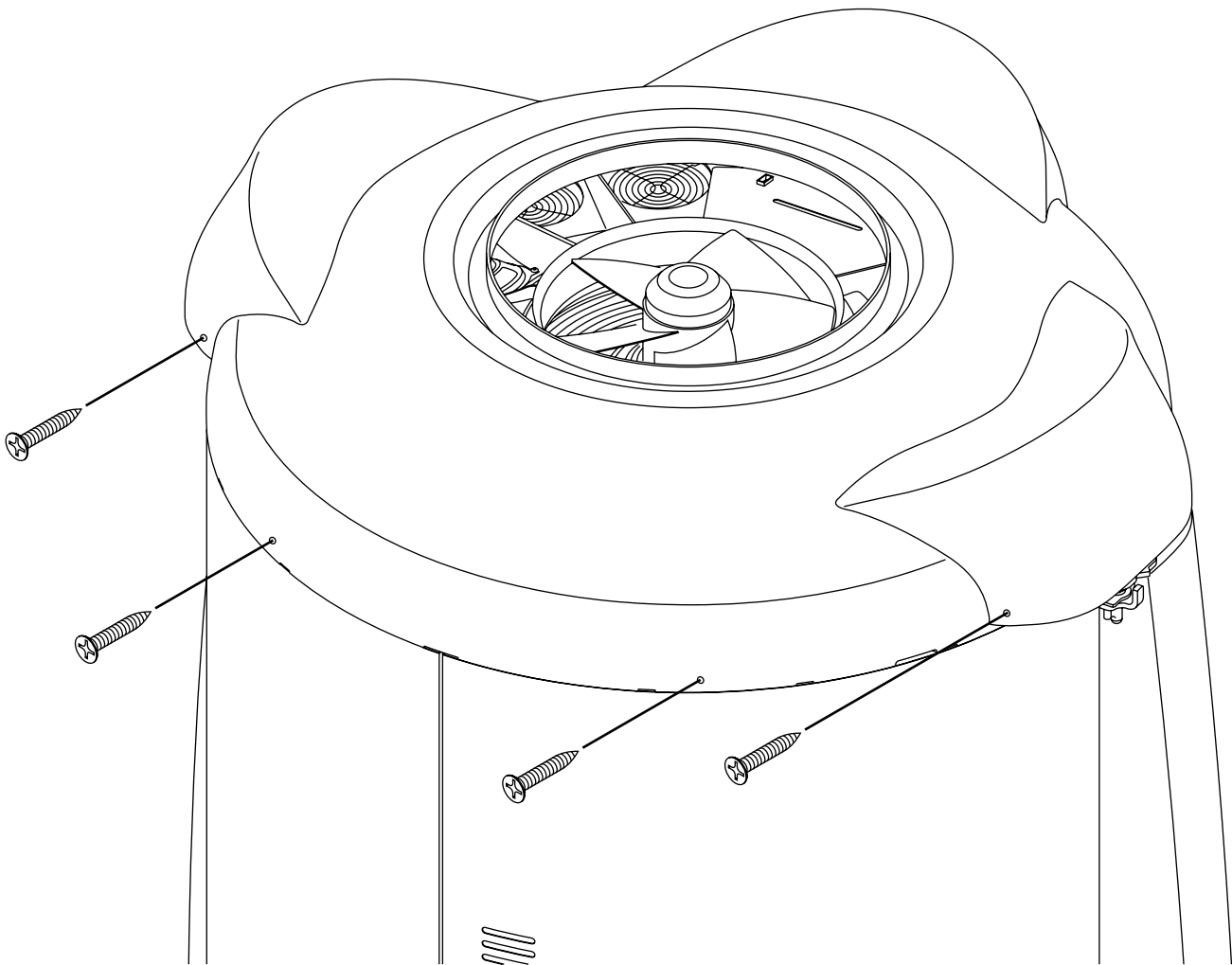
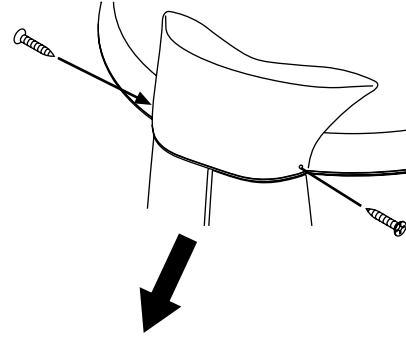

- Parts needed:
(2) Handles (box 8)
(2) Handle pins

The handles, although they look similar, are not the same. They will only fit properly one way. A slot is cut into the top of each handle that engages a tab inside the hole in the Ceiling assembly. Insert a handle into the hole, as shown, and twist it slightly to make sure it engages the tab.

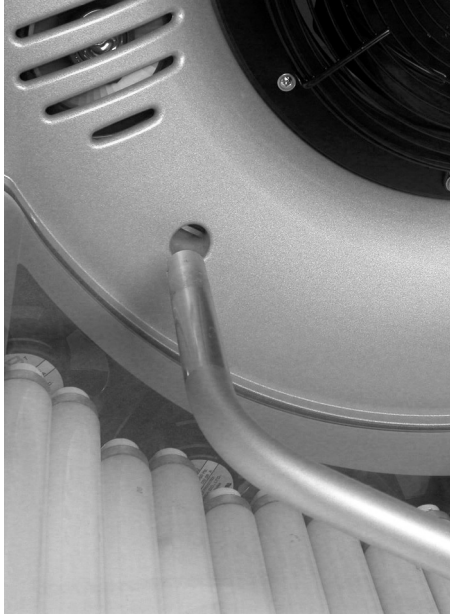

LEFT HANDLE
VIEWED
FROM TOP

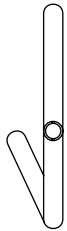

RIGHT HANDLE
VIEWED FROM
TOP

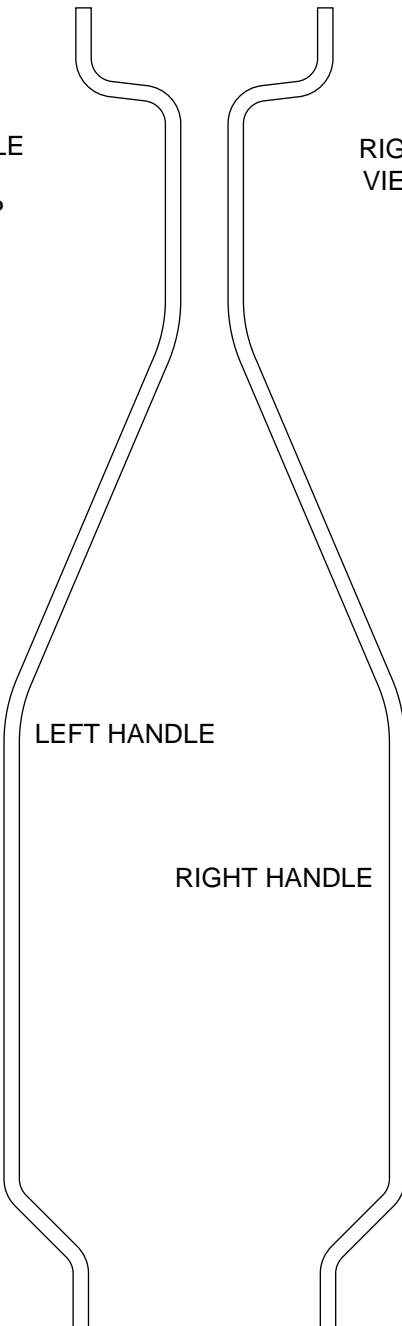

LEFT HANDLE

RIGHT HANDLE

Slide the bottom of the handle into the lower handle bracket and insert a handle pin through it to lock the handle in place.

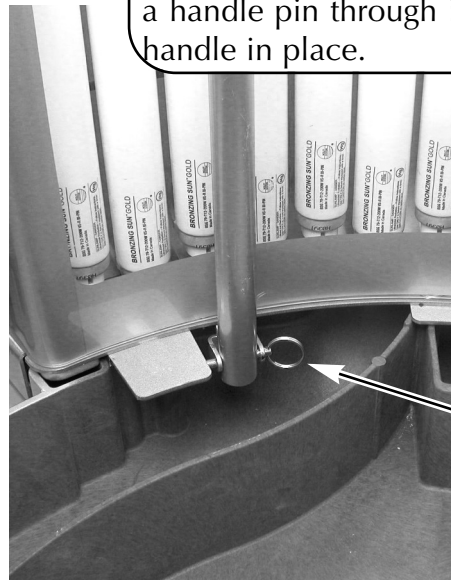

HANDLE PIN

22 - Assembly Procedures

Parts needed:
Booth Floor (box 7)

Place the Booth Floor on the Base. It locks in place with two 1/4 turn latches, one on each side near the handles. Use the acrylic key to lock the floor in place.

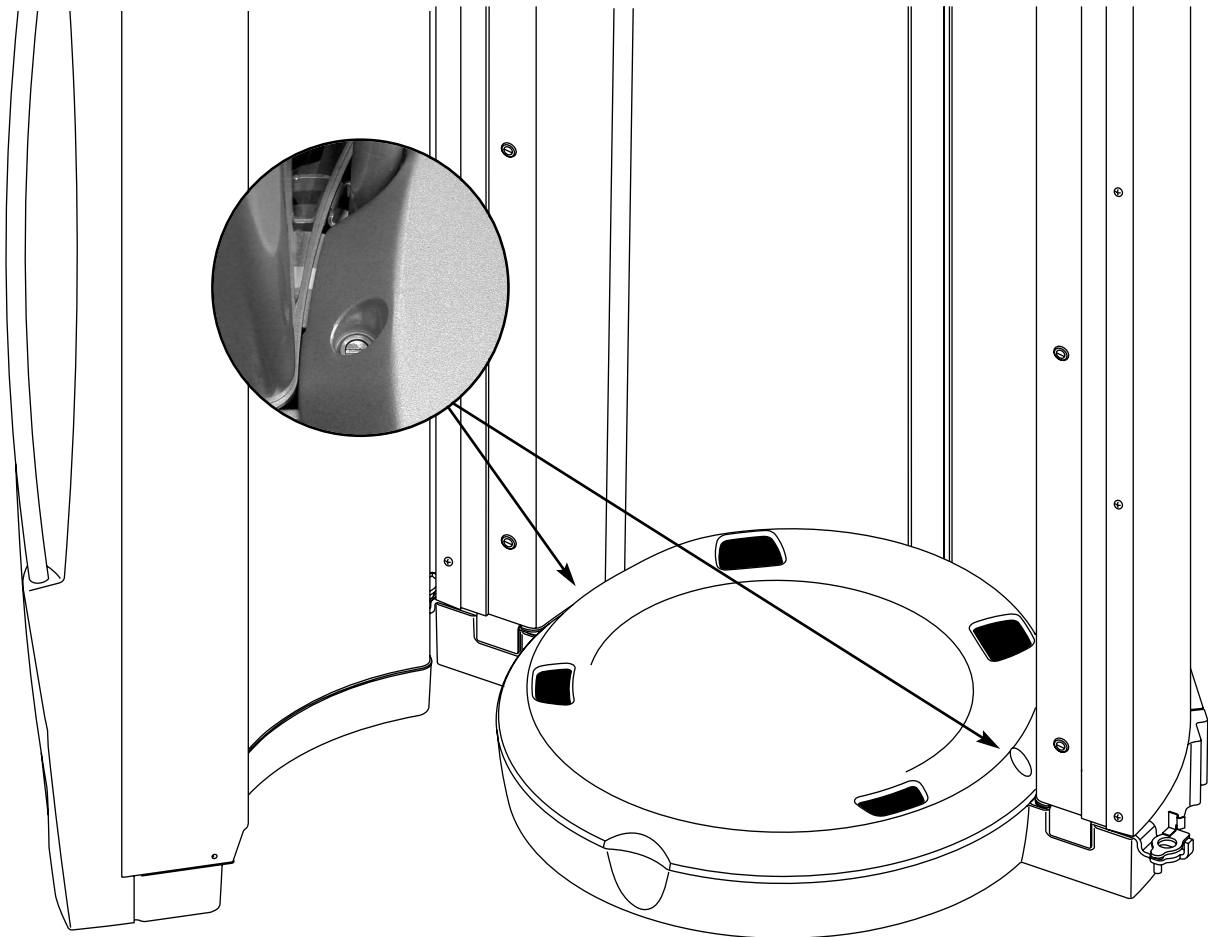

Parts needed:
Blowers (box 6)
(4) 1/4-20 x 5/8" Phillips pan head bolts

The Blower assemblies hook on the base and pivot into position (see detail below). Secure them in place with the bolts.

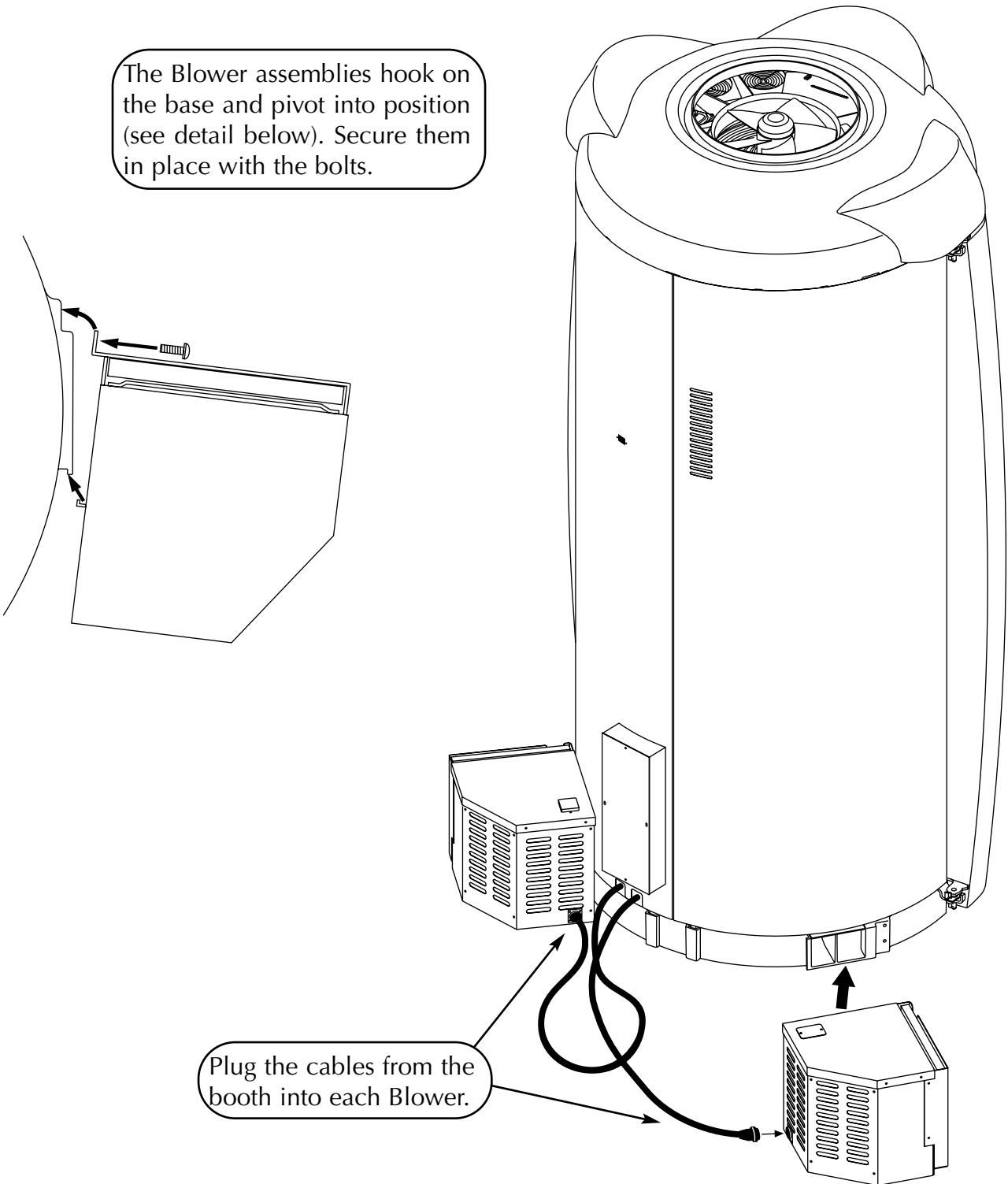

Adjusting Hinges

Parts needed:

(4) Hinge locking pins

The booth doors should close tightly, with an even seam between them. The hinges adjust to correct any door alignment problems. Loosen the lock nuts on the underside of a hinge (see photo) and adjust the door as needed. Tighten the lock nuts when the doors are adjusted properly.

Insert the Hinge Locking Pins into the Hinge Pins to prevent the doors from lifting off.

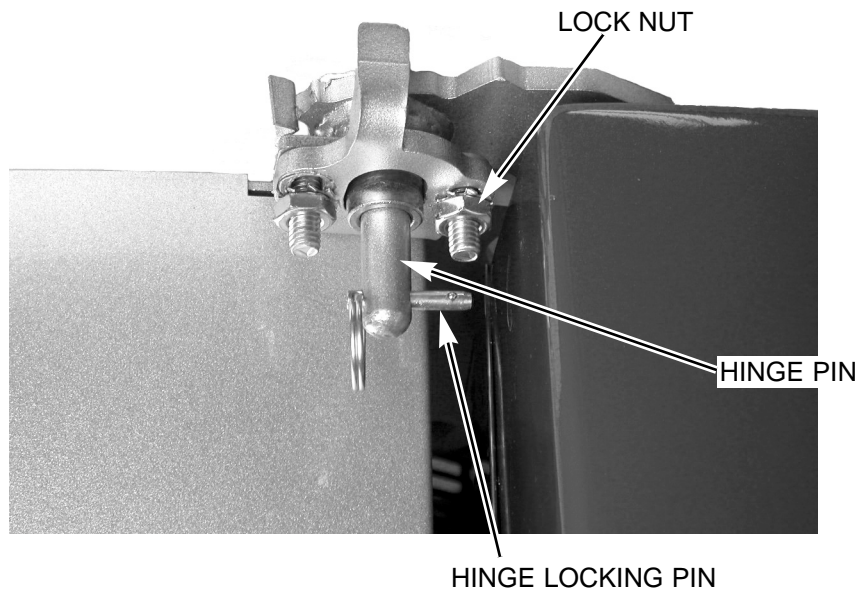

Stereo Installation

The ELITE 756V is designed to accept a stereo in the left door. Box 5 contains a stereo installation kit, complete with stereo and power supply. Follow the instructions included with that kit to install the stereo. The ceiling of the booth contains speakers.

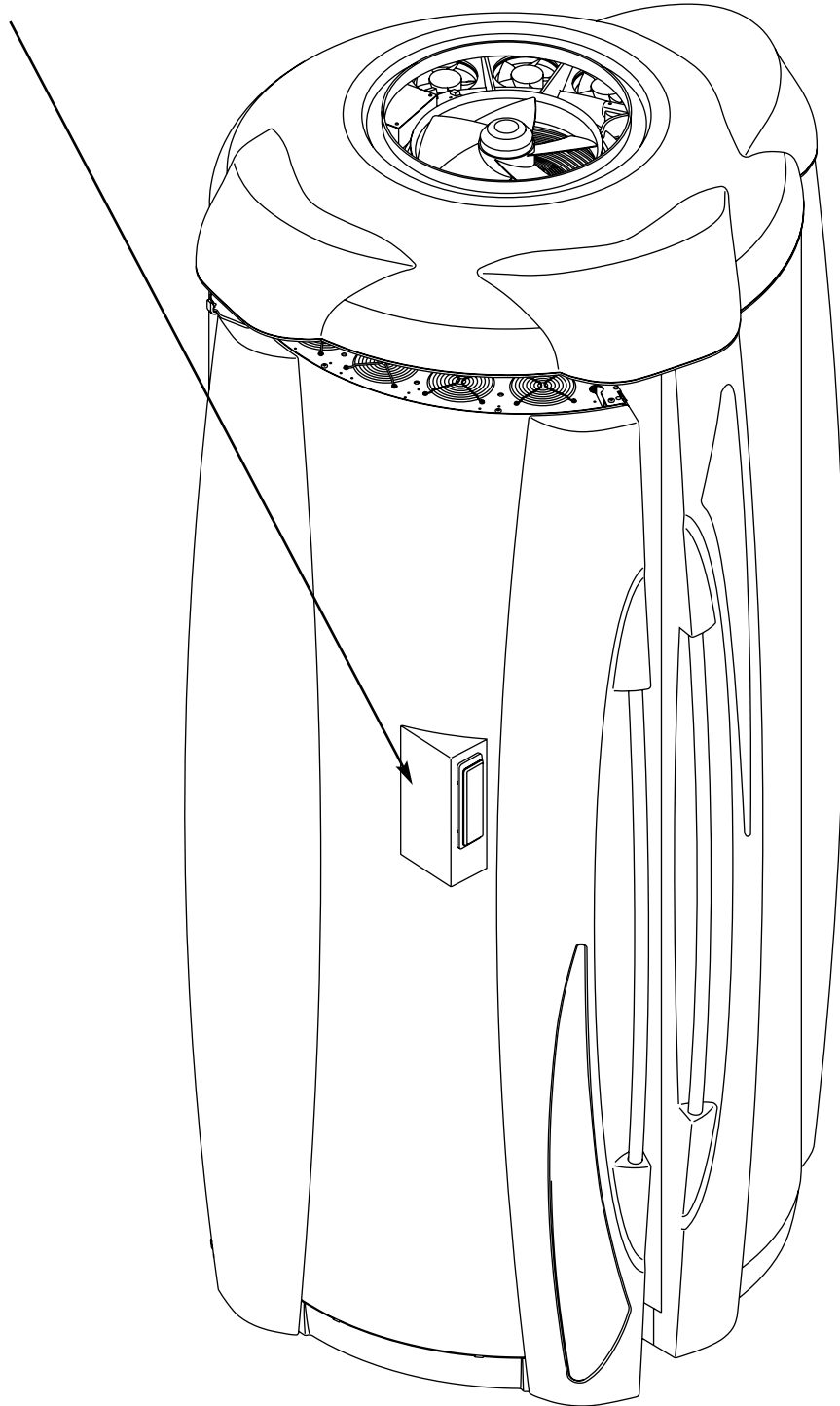

Electrical Connections

On the back of the booth is a junction box. Have your electrician connect power directly into this box as described in *Pre-Installation Planning*. Again, a professional electrician is recommended.

Your booth is designed to work with a remote control device. Three remote ports are located on back of the booth, two RJ-22 (4-wire) ports and one RJ-11 (6-wire) port. If you choose not to use a remote, insert the Remote Control Bypass plug into either of the smaller remote control ports as shown. Your booth will not operate without the Remote Control Bypass plug or a remote system connected. Your equipment is now ready for use.

In the ceiling of the booth are two speakers capable of handling 25W of musical power, with a maximum of 120W. Next to the remote control ports are two speaker inputs to connect to a stereo.

NOTE: Your unit is designed to accept an input from a remote control device. The remote control is optional. If you plan on using a remote system refer to *Remote Connections*.

ATTENTION: Although the Remote Control Bypass plug provided with your unit will work wherever a T-Max® terminator is called for in the series, the T-Max® terminator will not work as a bypass plug. A bypass plug is needed only when your booth is operated without a remote system connected.

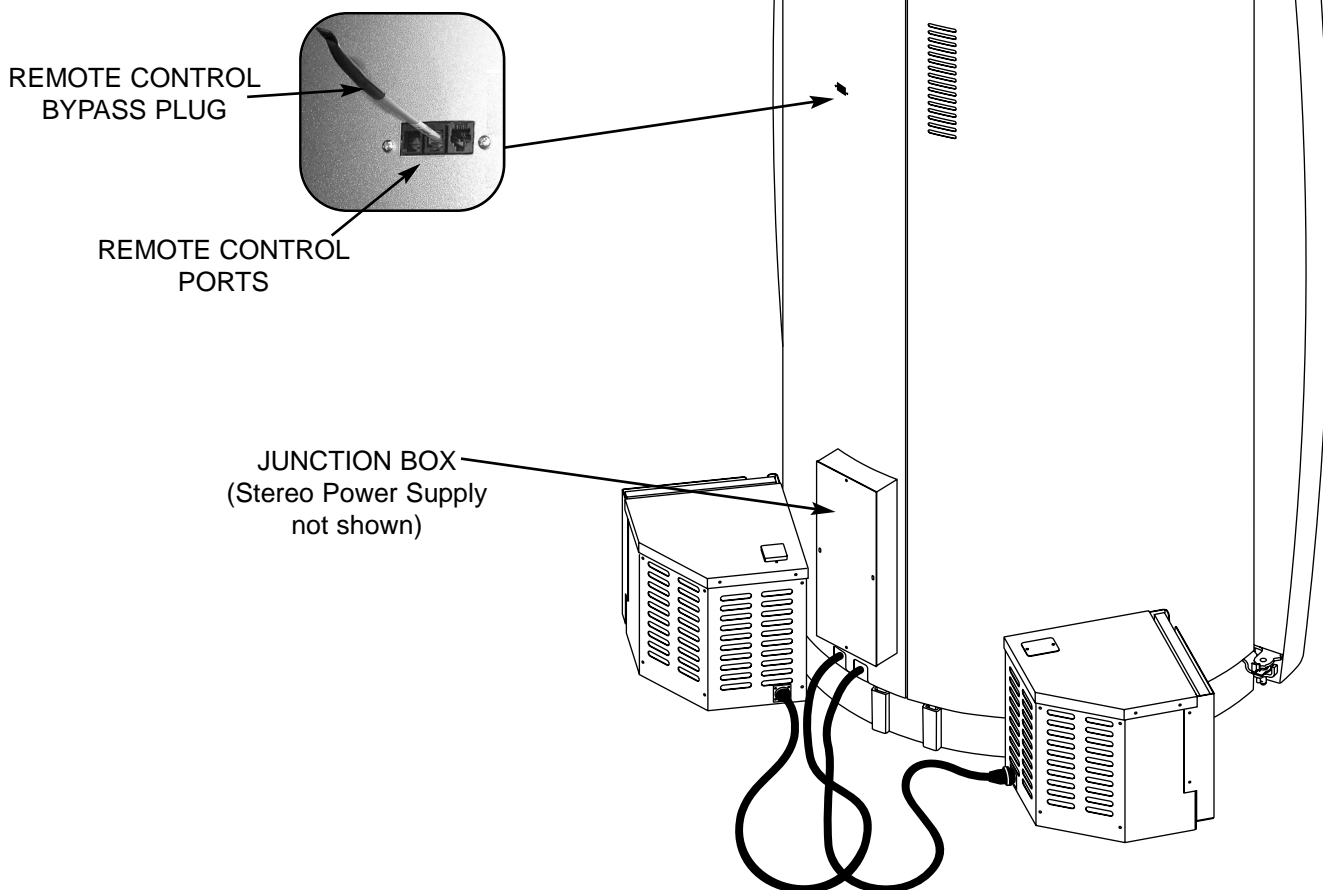

Remote Connections

Your tanning booth incorporates advanced circuitry allowing it to connect and communicate with most remote control systems. If a remote system is to be used, first determine whether the remote system is a T-Max® System or a standard remote system operating with a control relay. Follow the appropriate instructions for your system type.

CAUTION

The remote connection is not designed to supply or accept high voltage, nor can it provide power to an external timer. The sunbed's remote interface circuitry operates on 5 volts, attempting to connect it to any higher voltages will damage the sunbed as well as void your warranty.

T-Max® Products

The T-Max® remote systems offer the ultimate in sunbed control, while allowing the tanner easy straightforward operation. Your sunbed is configured to directly connect to this system, including the new wireless remote system. The circuitry inside your sunbed eliminates the need for the T-Max® 1A or 3A when connecting to the T-Max® Manager series. Your sunbed supports the auto addressing feature of the latest T-Max® Manager models and the following parameters: 5, 6, 7, 8, 9, 10, 15 and 23. See your T-Max® manual for descriptions of these parameters and how they function.

Go straight to the source with all your T-Max® brand remote questions: (417) 338-5101

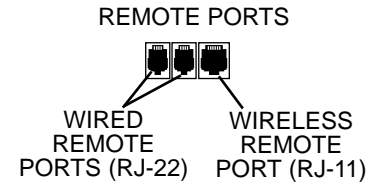

T-Max® Wireless Remote System

The T-Max® AP-900 eliminates wires in your salon, allowing easy setup without hiring an electrician to run wires. It also protects your investment from damage by isolating each unit from one another. Your sunbed arrives “wireless ready”, which means it connects directly to the T-Max® wireless system.

The T-Max® wireless system is available in two configurations: AP-900 Retail and AP-900 OEM. The Retail version contains a power adapter which plugs into a standard 110V outlet. The OEM version gets power from the tanning bed through the same RJ-11 cable it uses to communicate, eliminating the need for an outlet. Tanning beds labelled “wireless ready” use the AP-900 OEM.

Auto Addressing with T-Max®

Your T-Max® Manager manual will explain how to get into auto address mode. Once auto address has been activated, your booth display will blink “88”. Wait 10 seconds for the system to communicate properly and press the START button. The booth will flash “99” to signify it has accepted the address and return to “0:00”.

Remote System Hook-up Scenarios

Follow the diagrams on the following pages to see the many different scenarios for hooking up your salon. If you need further assistance, call T-Max® directly at (417) 338-5101.

Scenario 1 - T-Max® Manager Series with wires

This system is ideal for multiple sunbed installations. Simply connect the RJ-22 modular cable(s), described in the T-Max® Manager manual, into the remote port(s) located on the back of your booth and follow the instructions that came with your remote system. If you have an older T-Max® Manager that does not support auto addressing, set the address of each unit manually as described in *Setting the address manually*. You can place your booth at any location in the series.

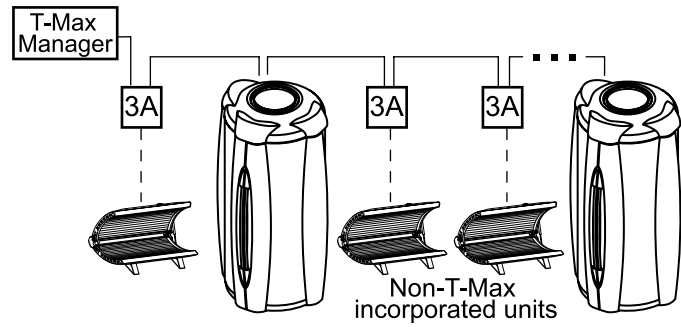

Scenario 2 - Single Booth wired to T-Max® 3A

In single sunbed installations, the T-Max® 1A and 3A can offer the same control as the T-Max® Manager, eliminating the need for a Manager. If you're using a 1A in this manner, it must have a chip labelled "master" installed on its circuit board. The remote control bypass plug must not be used in this configuration. The 3A may be used as a "master" with no modification.

After you have set the T-Max® 1A's, or 3A's, address to "0" (refer to your T-Max® user's guide) and the booth's address to "1", simply connect the RJ-22 modular cables, described in the T-Max® user's guide, directly into either of the smaller ports located on the back of the booth and either port on the back of the T-Max® 1A or 3A.

NOTE: A T-Max® 1A with a "master" chip can be substituted for a 3A.

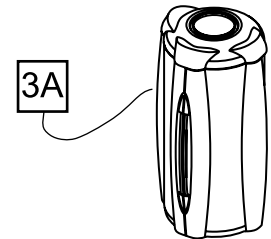

Scenario 3 - T-Max® Manager Series with Complete Wireless

Connect one AP-900 Retail to the Manager and one AP-900 OEM to each of the tanning units. Install as many units as you like with this configuration. Units that do not communicate with T-Max will need an AP-900 Retail and an additional 3A to operate.

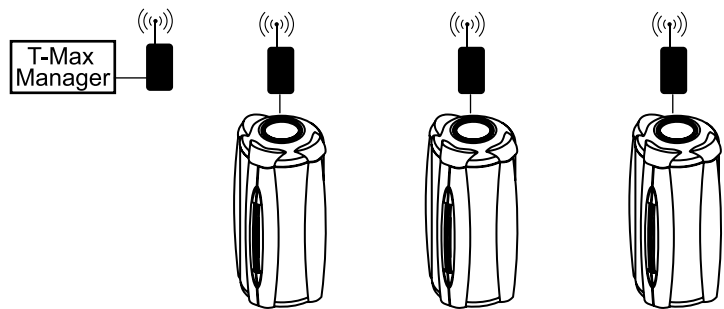

Scenario 4 - T-Max® Manager Series with Wireless combo

Connect one AP-900 Retail to the Manager and one AP-900 OEM to a wireless ready tanning unit. The rest of the salon may be "daisy-chained" together and connected to the wireless equipped tanning unit, eliminating the need to wire the Manager to the tanning equipment.

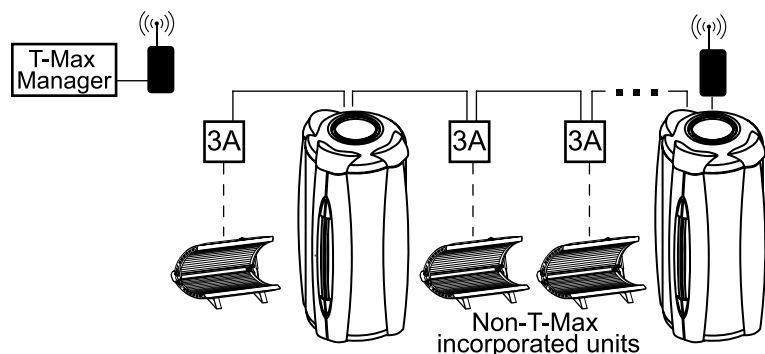

Scenario 5 - T-Max® Manager Series with Wireless combo 2

Wireless can be easily added to an existing salon already utilizing T-Max®. Connect one AP-900 Retail to the Manager and one AP-900 OEM to each wireless ready tanning unit. The rest of the salon may be “daisy-chained” together and connected to the Manager.

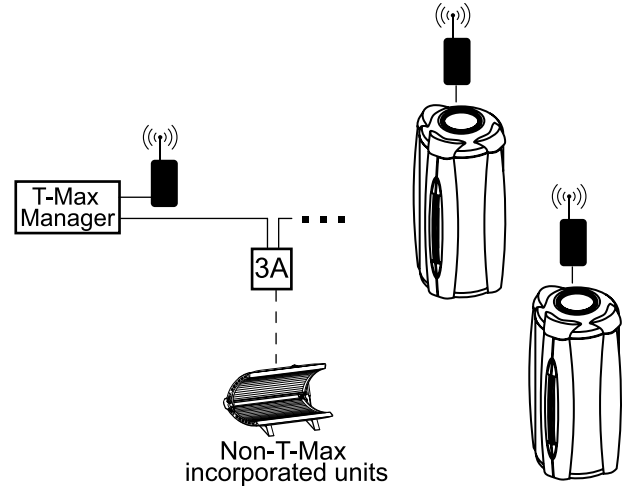

Scenario 6 - T-Max 3A with Wireless

Connect one AP-900 Retail to the T-Max® 3A and one AP-900 OEM to the booth in single unit installations.

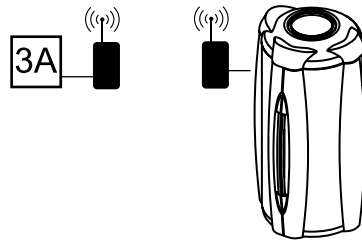

Setting the address manually

Before connecting your booth to the T-Max® Manager or T-Max® 1A or 3A, the address of your booth must first be set. Set the “id” manually as described below.

Setting the Address

1. Make sure the booth display is showing “0:00”.
2. Press the STOP button for three seconds. The display should indicate an address number from “1” to “255”.
3. If you are using a T-Max® 1A or 3A as a “master” remote, the address of the booth must be set to “1”. If you are using a T-Max® Manager each sunbed must be assigned a different address. To adjust the address, press the up arrow button to count up until the desired number (from 1 to 128) is achieved. Press the down arrow button to count down to the desired number. Addresses 252 to 255 are not normally used.
4. Press the STOP button to return to the normal display mode.

Scenario 7 - Non T-Max® Remote System wired to unit

Most non-T-Max® remote systems control the unit by the use of a relay. The relay operates the unit by connecting and disconnecting a pair of wires leading from the unit. Refer to the user’s manual provided with your remote system to determine if it operates in this way. The unit will begin a full session when the remote is activated. To connect your booth to this type of system a remote interface kit is required. Contact your place of purchase to obtain the kit. Follow the instructions provided with the kit and from the remote’s manual to make the necessary connections.

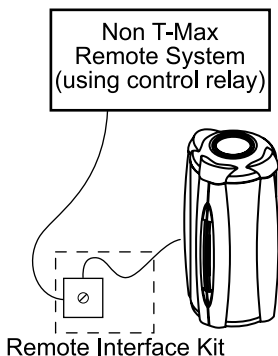

CAUTION

The remote connection is not designed to supply or accept high voltage, nor can it provide power to an external timer. The booth’s remote interface circuitry operates on 5 volts, attempting to connect it to any higher voltages will damage the unit as well as void your warranty.

Before You Tan

Please note the following warnings and precautions before using your tanning booth.

- Your skin should be free of cosmetics, tanning oils, or other body lotions prior to tanning except for those specifically made for use with tanning devices. However, do not remove natural body oils by bathing or showering immediately before tanning.
- This unit intended for individual use. Only one pair of eyewear is included.

Exposure Times

Follow the guidelines for skin type and exposure times as shown in the table below. Untanned persons should not tan on consecutive days during their first week of tanning. Never tan more than once a day. Tanning normally appears after the first few sessions and maximizes after approximately four weeks. Tan once or twice per week thereafter to maintain appearance. Persons already having a base tan may begin at advanced levels corresponding to the extent of their base tan.

Tanning Position

For best results, follow all directions carefully. To obtain a uniform tan, stand in the center of the booth and raise your hands. You may hold onto the interior handles wherever it feels comfortable. There is no need to turn yourself around while tanning.

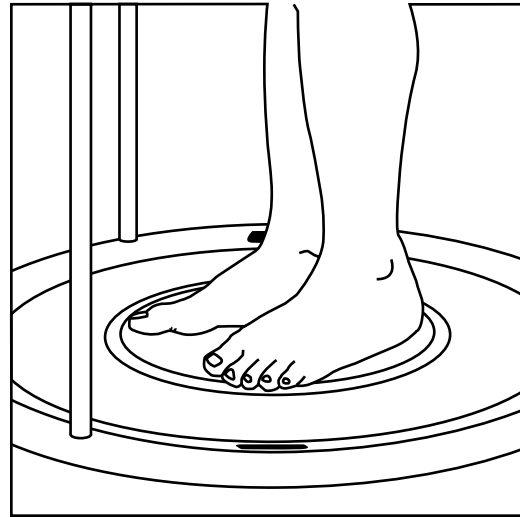

⚠ DANGER

Some medication may increase your sensitivity to ultraviolet light. It is recommended that you consult a physician before using this equipment if taking any medication or if you suspect that your skin might be especially sensitive to sunlight.



⚠ DANGER

**Shock hazard.
Do not operate this device near water or while you are wet.**

RECOMMENDED EXPOSURE TIMES IN MINUTES		MAXIMUM EXPOSURE TIME IS 8 MINUTES				
Skin Type:		Level 1/Week 1 1st-3rd Sessions	Level 2	Level 3	Level 4	Subsequent Maximum
I Sensitive Skin	(Burns easily and severely and does not tan.)	NOT RECOMMENDED FOR TANNING				
II Light	(Burns easily and severely and tans minimally.)	2	3	5	7	8
III Normal	(Burns moderately and tans average.)	3	4	6	8	8
IV Dark	(Burns minimally, tans easily and above average.)	4	5	7	8	8

Using Your Booth

When connected to the T-Max® Manager or T-Max® 1A or 3A.

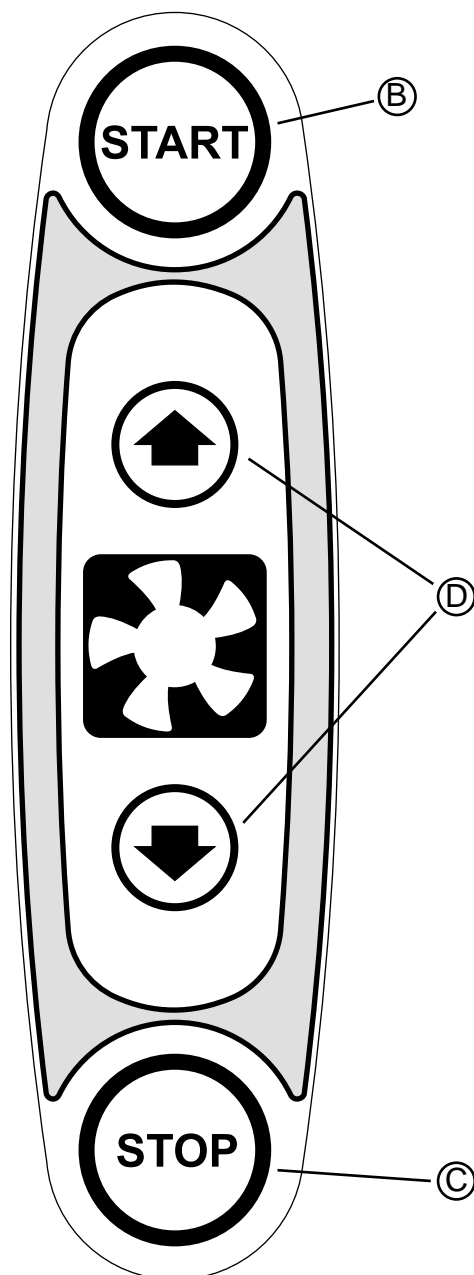
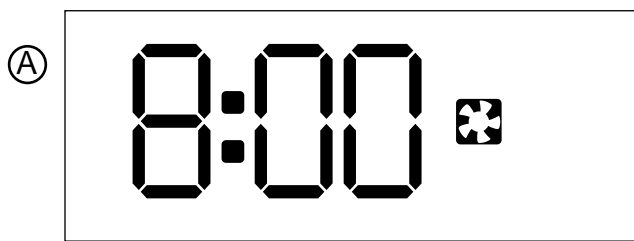

⚠ WARNING

Wear protective eyewear.
Failure to may result in severe burns or
longterm injury to the eyes.

- A **Timer display** - Displays remaining time and fan status.
- B **START button** - Turns unit on. Timer display shows remaining time.
- C **STOP button** - Interrupts tanning session.
- D **Body fan buttons** - Turns body cooling fans on and off. Indicator on display shows status.

1. Open the doors, step inside and close the doors fully. For best results, position your body in the center of the booth.
2. Put on your safety goggles.
3. Assuming the remote system has been set to allow a pre-tanning delay time, the timer display (A) will count down the remaining delay time. Press the START button (B) or wait until the delay time has expired to begin the tanning session. The lamps will turn on and the timer will begin to count down.
4. When the timer reaches 0 the lamps turn off. If you want to stop your session before time expires, press the STOP button (C).
5. Exit the booth. The cooling fans run for a period of time after the lamps shut off to aid in cooling the booth. The timer will indicate “:” as a reminder to clean the tanning surfaces. After the booth is cleaned, press the START button and the display will return to “0:00”.

Using Your Booth

When connected to a remote system using a control relay.

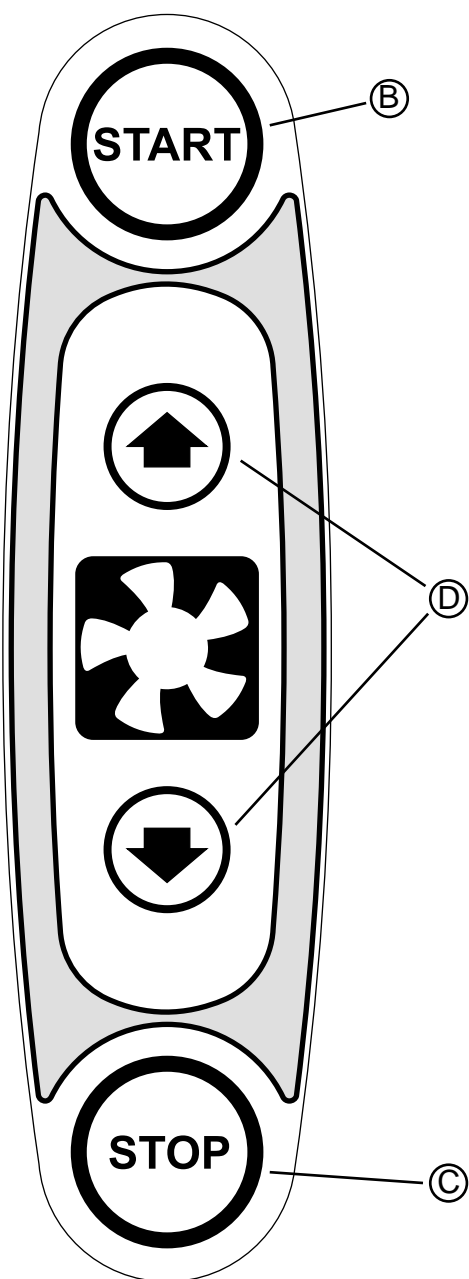
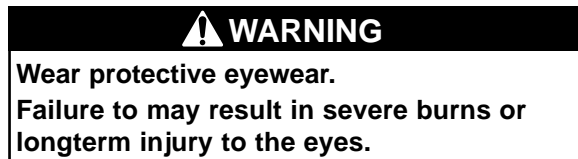
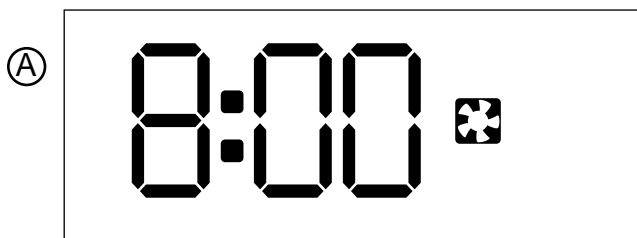

- A **Timer display** - Displays remaining time and fan status.
- B **START button** - Turns unit on. Timer display shows remaining time. If a lesser time is desired, press START button until desired time is displayed.
- C **STOP button** - Interrupts tanning session.
- D **Body fan buttons** - Turns body cooling fans on and off. Indicator on display shows status.

1. Open the doors, step inside and close the doors fully. For best results, position your body in the center of the booth.
2. Put on your safety goggles.
3. As soon as the remote timer is activated the unit starts at the maximum time. The lamps will turn on and the timer will begin to count down.
4. If a tanning time less than the displayed time is desired, repeatedly press the START button (B) to decrease the remaining time.
5. When the remote timer expires, or the booth timer reaches 0, the lamps turn off. If you want to stop your session before time expires, press the STOP button (C). You will have ten seconds to restart with the remaining time, otherwise the timer will reset to 0:00.
6. Exit the booth. The cooling fans run for a period of time after the lamps shut off to aid in cooling the booth.

Using Your Booth

When used as a stand alone unit.

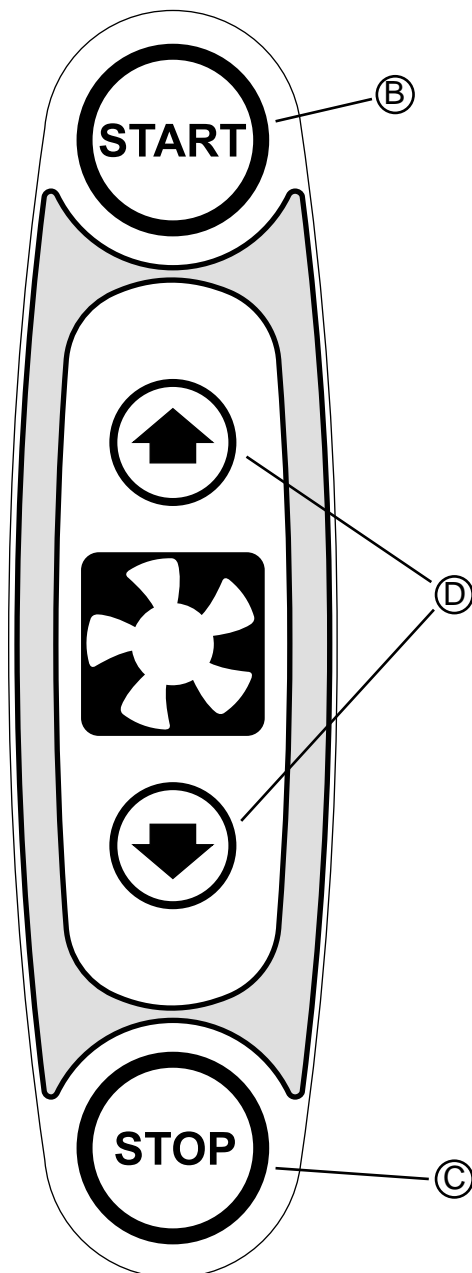
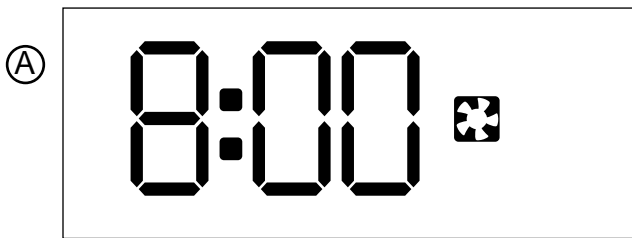

WARNING

Wear protective eyewear.
Failure to may result in severe burns or longterm injury to the eyes.

- A Timer display** - Displays remaining time and fan status.
 - B START button** - Turns unit on. Timer display shows remaining time. If a lesser time is desired, press START button until desired time is displayed.
 - C STOP button** - Interrupts tanning session.
 - D Body fan buttons** - Turns body cooling fans on and off. Indicator on display shows status.
1. Open the doors, step inside and close the doors fully. For best results, position your body in the center of the booth.
 2. Put on your safety goggles.
 3. Press the START button (B) to begin the tanning session. The lamps will turn on and the timer will begin to count down.
 4. If a tanning time less than the displayed time is desired, repeatedly press the START button (B) to decrease the remaining time.
 5. When the timer reaches 0 the lamps turn off. If you want to stop your session before time expires, press the STOP button (C). You will have ten seconds to restart with the remaining time, otherwise the timer will reset to 0:00.
 6. Exit the booth. The cooling fans run for a period of time after the lamps shut off to aid in cooling the booth.

Cleaning After Use

Clean and disinfect the acrylics, floor and handles after each use. Use a non-abrasive disinfectant cleaner that **does not contain ammonia or ammonia derivatives**. Ammonia may damage the acrylic shield. Spray the acrylic lightly with disinfectant and wipe dry with a clean soft cloth. We recommend Australian Gold® pH Neutral Disinfectant Cleaner.



Hour Counter

Your booth is equipped with an hour counter that tracks how long the unit has been in service, much like your vehicle's odometer. The hour counter is located on the top of the right blower, behind the unit. Use this counter to track lamp hours and many other time based maintenance procedures.

Thorough Periodic Cleaning

Introduction

The cooling fans draw air through the booth and over time will cause a dust buildup on the lamps and reflectors. This will reduce the tanning effectiveness of the unit. When a dust buildup is observed, it is necessary to thoroughly clean the inside of the booth.

- Open the acrylic shields and remove lamps as described in *Lamp and Acrylic Replacement*.
- With a soft cloth, wipe the entire length of each lamp to remove any film buildup.
- Clean both sides of the acrylic shields with a non-ammonia disinfectant cleaner.
- Wipe the reflectors with a clean damp cloth.
- Reinstall the lamps and acrylic shields.
- Replace air filters inside each blower. Replace with a 12" x 12" x 1" furnace filter.

Mechanical Inspection

Your tanning booth has been built for years of service. To ensure trouble-free operation throughout its life, inspect the unit's mechanical integrity every 400-500 hours of use.

- Inspect the unit's fasteners verifying that all are firmly in place.
- Inspect door alignment. Adjust hinges so doors close tightly with an even seam between them. See *Adjusting Hinges*.
- Inspect all power cords and connections.
- Inspect the acrylics. Broken, cracked or badly scratched acrylics should be immediately replaced.

Lamp and Acrylic Replacement

Introduction

To be assured of maximum tanning effectiveness, change lamps after approximately 500-700 hours of use. Tanning will continue after this time but at a slower rate. To ensure trouble-free operation of your booth, replace the lamp starters whenever the lamps are replaced.



Opening/Replacing Acrylic Shields

Each acrylic shield is secured in place by four quarter-turn latches. The Left Module is shown at right. Using the acrylic key (included in the hardware kit) remove the floor. Then use it to unlock the acrylic. ① Swing the acrylic open, ② lift it and ③ pull the bottom out.

To replace the acrylic, insert the top hinge pin in the hole at the top of the module, swing the bottom pin into place and drop it down to engage the pin.

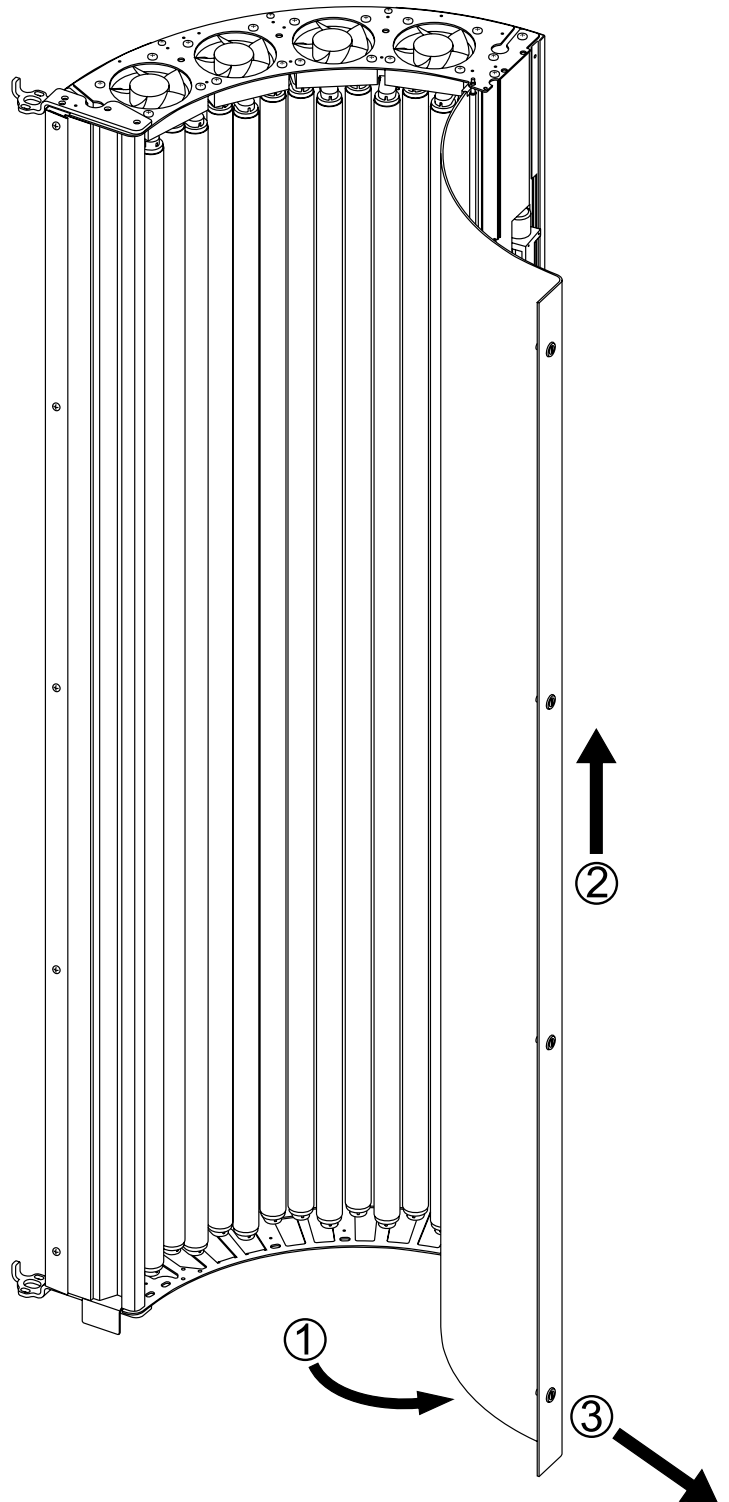

Removing/Replacing Main Lamps

After opening the acrylic, grasp a lamp at one end and at the middle and turn the lamp one quarter turn. Gently remove the lamp from its holders.

Reinstall the lamp by inserting the pins located on the ends of the lamp into the slots on top of the lamp holders and turn the lamp a quarter turn. It should click in place.

Removing/Replacing Main Lamp Starters

The top of the starter is visible after removing a lamp. There is one starter for each lamp. Grasp the starter and turn it gently. It will click loose and pull out easily.

Reinstall the starter by inserting the pins located on the bottom of the starter into the holes in the starter holder and turning. It should click in place.

Recommended Replacement Lamps

We recommend using the lamps specified below. Use of uncertified lamps is a violation of Federal regulations and will void your warranty. These lamps have an average life of 500-700 hours of effective tanning use. Lamps used longer than that begin to lose their effectiveness even though they continue to light.

Recommended Replacement Acrylics

Acrylics vary greatly over time in their ability to effectively transmit UV light. Acrylics sold by ETS have been life tested to ensure proper transmission throughout their useful life.

ONLY THE FOLLOWING LAMPS HAVE BEEN CERTIFIED FOR USE IN THIS EQUIPMENT:

BRONZING SUN™ GOLD Wolff® Model BSG 79-T12-200W VS-R BI-PIN

Replacing Decorative Door Lamps

Inside each door is a small fluorescent lamp which illuminates the decorative window. To access these lamps you must first remove the door acrylic and the first 8 lamps (starting from the handle side). Follow these directions carefully.

Behind the door lamps are two, side-by-side reflectors (the left door is shown at left). Remove the one closest to the handle side by unscrewing the four screws holding it in place. This will reveal the decorative lamp access panel (below center).

The decorative lamp access panel is held in place by three screws. Removing this panel exposes the decorative lamp and its starter (below right). Replace both of them at the same time.

Reverse the above directions to reassemble the door.

Replace the lamps with a 25Watt, 36", T8 lamp.

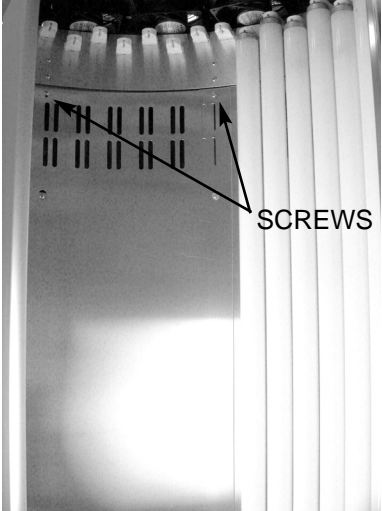

TOP

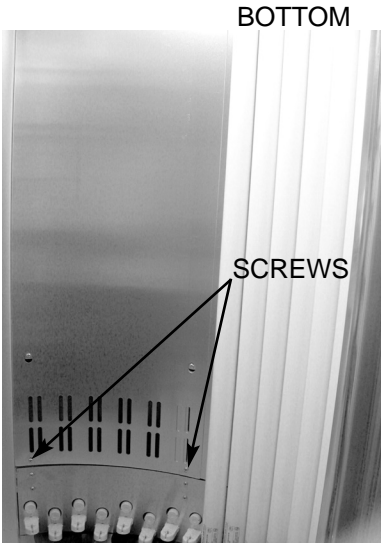

BOTTOM

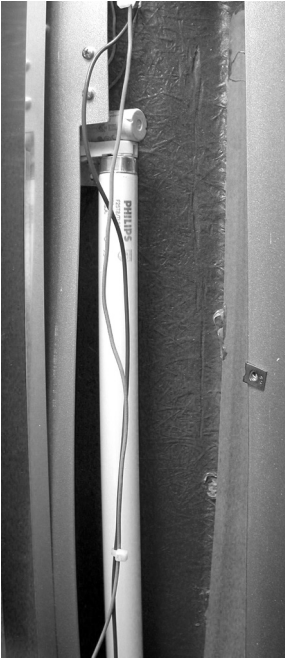
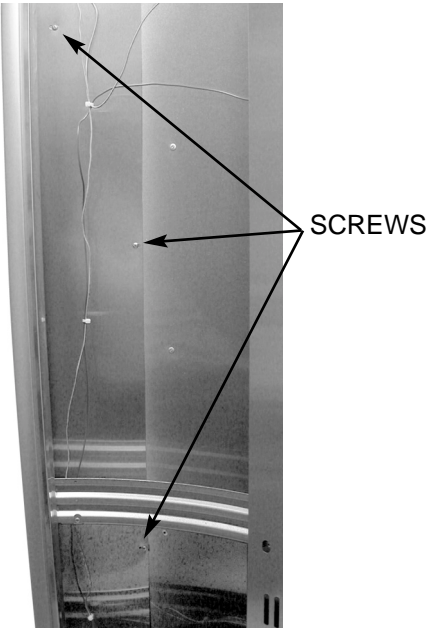

Replacing Entry Lamps

Above the doors are two small fluorescent lamps to illuminate the inside of the booth when the tanning lamps are off. To access these lamps you must first remove the Dome. Follow these directions carefully.

Unscrew the six screws around the Dome. Lift the Dome off the unit.

On the front of the ceiling assembly is an oddly shaped metal panel (see below). Four screws hold it in place. Remove the screws and carefully lift the panel. Be careful not to pull on the wires running through the panel. Turn it over to reveal the lamps (right).

Grasp the lamp by its base, not the lamp glass, and pull it straight out of the lamp holder. Replace the lamp by lining up the pins on its base with the lamp holder and pressing it firmly into place.

Reverse the above directions to reassemble the Dome.

Replace with Philips Alto PL-C 26W/35/2P or equivalent.

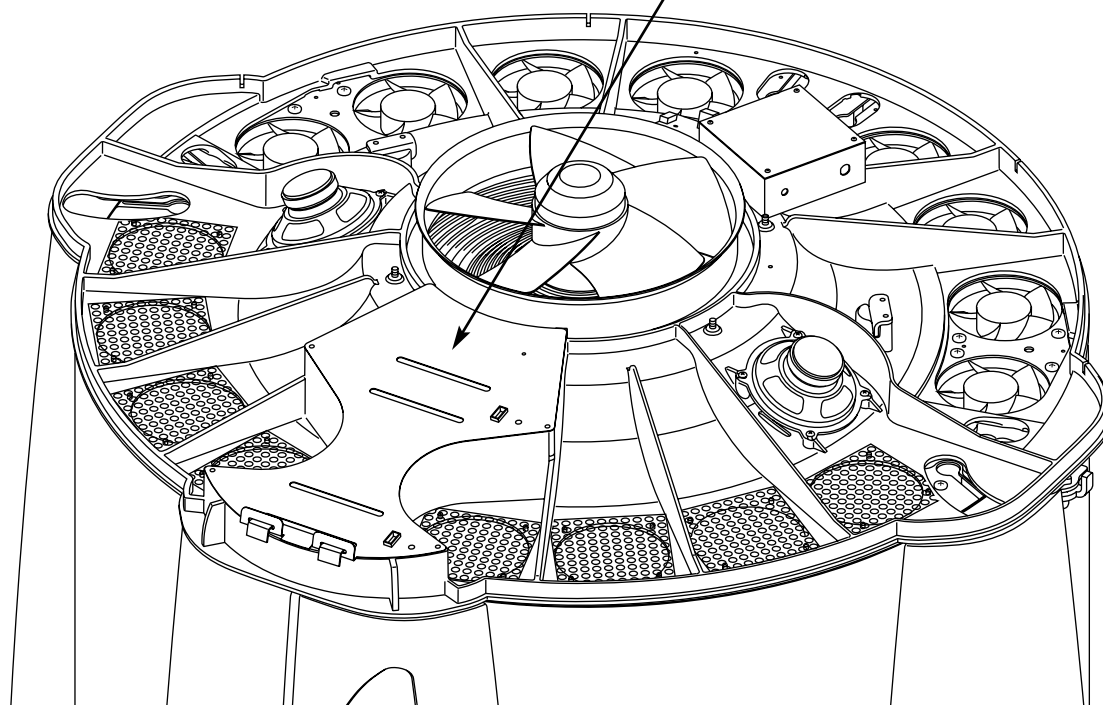

NOTE: Wiring deleted from illustration for clarity.

Problem	Cause	Solution
Booth not tanning	<ol style="list-style-type: none"> 1. Booth dirty 2. Low voltage 3. Lamps old 4. Acrylics scratched 	<ol style="list-style-type: none"> 1. Clean booth, see Thorough Periodic Cleaning. 2. Ensure supply voltage is between 208 and 230V AC. 3. Replace lamps if lamp hours are greater than 700hrs. 4. Replace acrylic.
Lamps fail to light and timer display is blank	<ol style="list-style-type: none"> 1. Unit unplugged 2. Circuit breaker tripped 	<ol style="list-style-type: none"> 1. Make sure the unit is connected to a power source. 2. Check source of AC power. Reset circuit breaker or replace fuse.
One or more lamps fail to light	<ol style="list-style-type: none"> 1. Lamp loose 2. Lamp burnt out 	<ol style="list-style-type: none"> 1. Check that lamp is installed correctly. 2. Switch unlit lamp with a lamp that lights, if new lamp lights and old lamp still does not, replace old lamp.
Booth getting too hot	<ol style="list-style-type: none"> 1. Not enough airflow 2. Salon too hot 3. Air filters clogged 4. Voltage too high 	<ol style="list-style-type: none"> 1. Turn body fan on. 2. Ambient temperature of salon room must be below 80° at all times. 3. Check air filters. Change if dirty. 4. Input voltage, with unit running, must be less than 230VAC.
Body cooling fans won't turn off	Temperature sensor on timer board indicated unit is too hot and turned the fans on.	None. Timer display will show blinking fan indicator when timer board has activated fans. They cannot be turned off until unit cools down.
E 91 showing on display	Timer computer not functioning properly	<ol style="list-style-type: none"> 1. Disconnect then reconnect power to reset timer. 2. Contact servicer to replace main timer.
E 92 showing on display	Current sensor indicating unit is off when it should be on	Contact servicer.
E 93 showing on display	Current sensor indicating unit is on when it should be off	Contact servicer.
E 98 showing on display	Unit temperature exceeded	<ol style="list-style-type: none"> 1. Allow unit time to cool. 2. Check all fan openings and air filters for obstructions. 3. If problem persists, contact servicer.

Problem	Cause	Solution
I forgot what address I set my sunbed to		By holding the STOP button for 3 seconds the timer display will briefly blink "id" and your address number.
Timer display changes to indicate a tanning time after the START button is pressed but lamps do not come on	<ol style="list-style-type: none"> 1. Bypass plug not installed 2. A non-SunStar® bypass has been used 3. Remote not set 4. Remote wiring incorrect 	<ol style="list-style-type: none"> 1. See <i>Electrical Connections</i>. 2. See <i>Electrical Connections</i>. 3. If remote is being used, other than T-Max® Manager, the external timer may not be activated. 4. See the instructions provided with the remote interface kit.
My bed is connected to the T-Max® Manager remote system and when the delay time has expired the timer display starts counting down but the booth lights do not come on	Auto-start not on	The auto start feature of the remote system is disabled, see the instructions provided with your remote system.
My booth won't work with the T-Max® Manager remote system	<ol style="list-style-type: none"> 1. Address incorrect 2. Terminator plug installed incorrectly 	<ol style="list-style-type: none"> 1. The booth must first be set to a unique address, see <i>Remote Connections</i>. 2. The bypass or terminator plug may be installed in the series in an inappropriate location. Plug the bypass plug only into the bed at the end of the series.
I frequently disconnect my sunbeds from the T-Max® chain and interrupt the rest of the units		A T-Max® Inline 4-Pin Connector is available from ETS, Inc. which connects the chain without a sunbed.
Timer display continues to show 0:00 after the START button is pressed		<ol style="list-style-type: none"> 1. T-Max® Manager remote system has not yet been set. 2. Booth address is not set correctly, see <i>Remote Connections</i>.

Problem	Cause	Solution
<p>My booth, connected to a T-Max® Manager, did not display a delay time but does indicate: 0:00</p> <p>a tanning time and the lamps have come on</p> <p>a tanning time but the lamps have not come on</p>	<ol style="list-style-type: none"> 1. Remote device has not been set 2. The booth has not been connected to the remote system <ol style="list-style-type: none"> 1. Delay time of T-Max® Manager has not been set 2. Delay time has expired <p>Auto-start not on</p>	<ol style="list-style-type: none"> 1. Set remote device. 2. See <i>Remote Connections</i>. <ol style="list-style-type: none"> 1. Set delay time on T-Max® Manager. 2. Set a longer delay time if desired. <p>Auto start function of T-Max® Manager has been turned off. Press the START button to turn on lamps.</p>
<p>When auto-addressing the first bed does not register an address</p>		<p>When using the auto address feature of the T-Max® Manager you must wait 10 seconds from the time you start the auto address function before addressing the first bed.</p>
<p>When using a T-Max® 1A my booth won't function properly</p>	<p>Terminator plugs not installed</p>	<p>Remote Bypass plugs or terminator plugs may be needed if the T-Max® 1A and the booth are over 100 feet apart. Install the plugs in the open remote port in the booth and the T-Max® 1A.</p>
<p>My salon suffers frequent, short power outages and clients complain about losing session time</p>		<p>If you have a T-Max® Manager, changing parameter 23 from "0" to "1" will allow the tanning booth to remember how much time was left when power goes out and resume its session after power is restored. Consult your T-Max® Manager manual for information on setting parameters.</p>

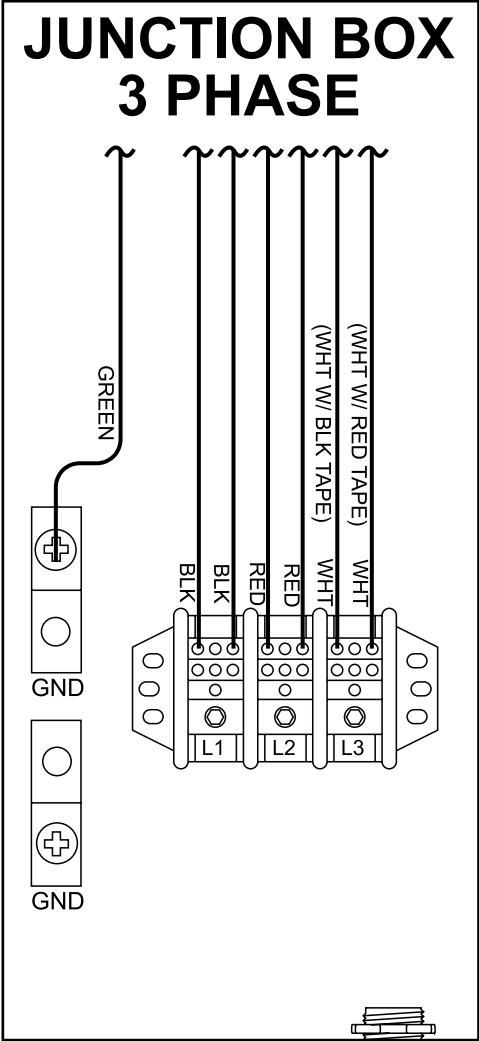

**UNIT WIRED
3 PHASE
FROM FACTORY**

MAIN POWER IN

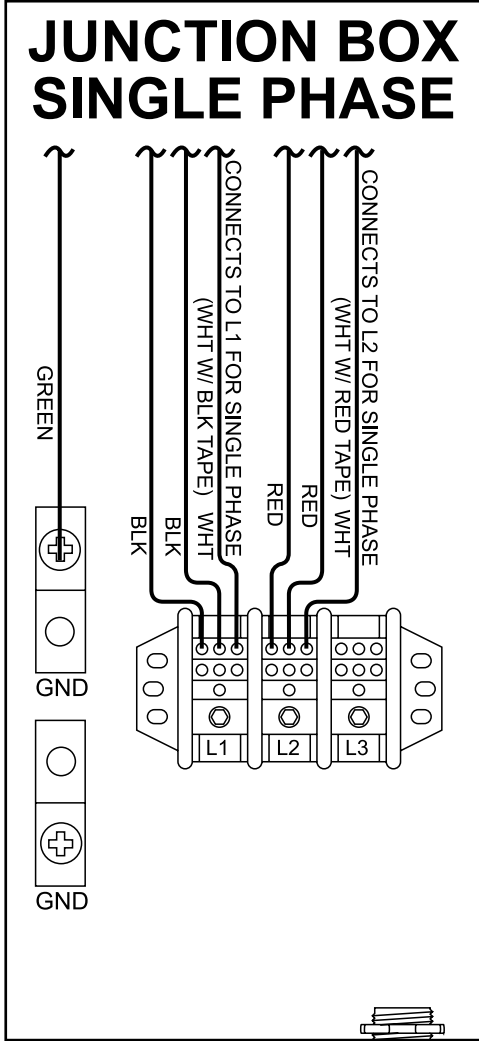

**IF REWIRED FOR
SINGLE PHASE -
CURRENT @220VAC
IS 69A**

MAIN POWER IN

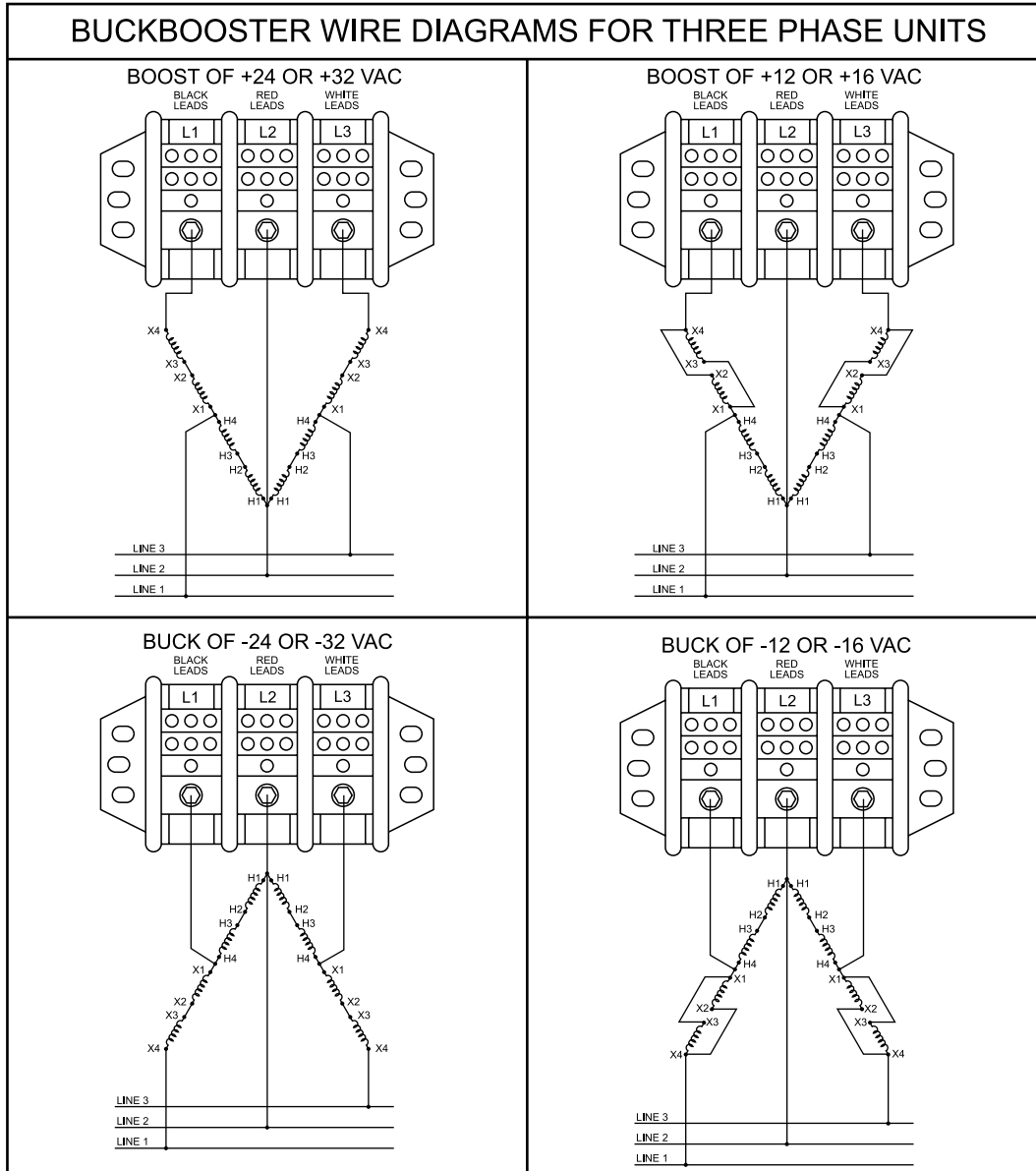

STANDARD 48 MONTH WARRANTY

Your tanning unit is warranted to be free of structural defects in material and workmanship, under normal use, for its lifetime. **ETS, Inc.** will, at its discretion, repair any structural defect which materially affects the performance of the tanning unit, or replace the tanning unit.

For forty-eight (48) months following the shipping date of your tanning unit, **ETS, Inc.** will provide replacements for parts that prove to be defective in material or workmanship. Fluorescent lamps, and lamp starters are warranted against manufacturer's defects for a period of ninety (90) days following the shipping date of your tanning unit. Acrylics will be warranted against manufacturer's defects for a period of 2 years (prorated).

Labor costs associated with repair or replacement work covered by this warranty will be reimbursed for repair or replacement work required to be performed for a period of one (1) year following the shipping date of your tanning unit. Normal wear and tear, damage from misuse or abuse, damage incurred in transit or damages resulting from unauthorized repairs or modifications are not covered by this warranty. Warranty coverage does not include cosmetic abnormalities such as scratches, nicks, dents, or other cosmetic changes that do not materially interfere with the function of the tanning unit.

THIS STANDARD 48 MONTH WARRANTY IS EXPRESSLY MADE IN LIEU OF ANY OTHER WARRANTIES, EXPRESS OR IMPLIED, INCLUDING ANY IMPLIED WARRANTIES OF MERCHANTABILITY AND FITNESS FOR A PARTICULAR PURPOSE, WHICH ARE HEREBY DISCLAIMED. No one has the authority to change or modify this Standard 48 Month Warranty in any respect. To obtain service under this Standard 48 Month Warranty, contact **ETS, Inc.** at **1-800-449-3605**, and ask for the Technical Service Department. Proof of purchase, including serial number, is required.

IN NO EVENT SHALL THE MANUFACTURER BE LIABLE AT LAW OR IN EQUITY FOR ANY LOSS, LIABILITY, DAMAGE OR EXPENSE IN AN AMOUNT IN EXCESS OF THE PURCHASE PRICE RECEIVED, OR FOR LOSS OF USE OR PROFITS, LOSS OF TIME, INCONVENIENCE, RENTAL OR SUBSTITUTE PRODUCTS, LOSS OF BUSINESS, LOSS OF INCOME, OR ANY OTHER INCIDENTAL, INDIRECT, SPECIAL OR CONSEQUENTIAL DAMAGES. Some states do not allow the exclusion or limitation of incidental or consequential damages, and the above limitation or exclusion will not apply to residents of some states. This Standard 48 Month Warranty gives you specific, legal rights and you may have other rights which may vary from state to state.

All warranty service must be performed by an authorized service person. All labor charges must be authorized by **ETS, Inc.** prior to the start of repairs and must not exceed the established rates and time allotment policies established by **ETS, Inc.** If your tanning unit must be returned for service, all freight charges shall be at your expense. Contact **ETS, Inc.** for the authorized Service Center nearest you. This warranty is serial number specific and only applies to tanning units purchased through an authorized ETS Distributor. This warranty is extended to the individual or legal entity whose name appears on the original sales document and may not be transferred to any other individual or legal entity. This warranty is void if the tanning unit is modified in any manner from its original design.

To file a Warranty Claim, please follow these steps:

1. Locate the silver serial number label, located on the back of the unit near the junction box. Identify the serial number and model number of the unit.
2. Proof of purchase must be provided before any claim will be considered.
3. Contact **ETS, Inc.** at **1-800-449-3605**.
4. If it is determined that a defective part needs to be replaced, your service representative will arrange for the pick-up or shipment of the replacement part.

Record this information for ease of service:

Date of purchase: _____

Serial number: _____

ELITE 756V

Size

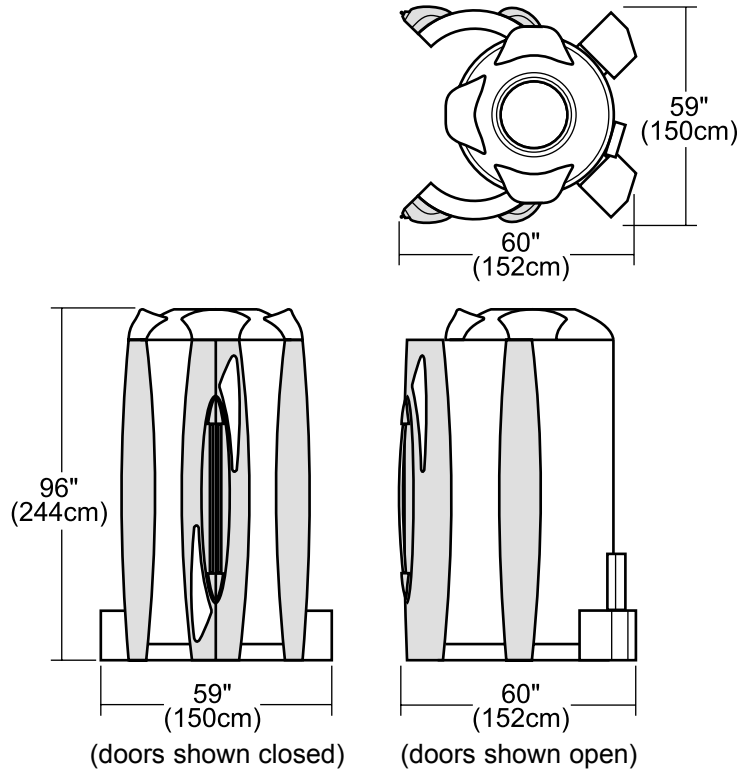

Recommended Room Size	7' x 8' (2.1m x 2.7m)
Weight	1045 lbs. (475 kg)
Electrical -	
Voltage (AC)	220
Amperage	40A 3-phase 69A 1-phase
Outlet	Booth hardwired
Main Lamps	56 x BRONZING SUN™ GOLD 200W
Ballasts	200W
Body Cooling System	2 x high power blowers from base, face blower, overhead fan
Speakers	2 x 25W (120W max) 2-way speakers
Timer System	Digital
Max. Exposure Time	8 minutes
Back-up Timer	Digital "watchdog" circuitry
Remote Capability	T-Max® compatible

U.S. Patent 6,660,025 B2



CALL FOR SERVICE OR QUESTIONS: 1•800•449•3605
7445 Company Drive, Indianapolis, IN 46237-9296

